

Assembly Instructions

⚠ Important ⚠

Before you begin, read and comply with all safety and operating instructions, and ensure all parts and correct quantities are included.

Any parts damaged during shipment must be reported within 5 days of receipt. To report information regarding missing parts or damage, to purchase parts or accessories, or if you have any questions, please contact us.

www.spectrumfurniture.com
800-235-1262, 715-723-6750

Thank you for purchasing Spectrum products!

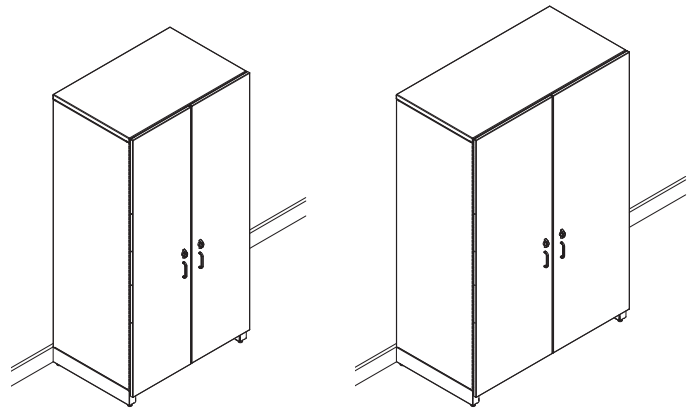

SC36 36"W

SC48 48"W

SC36 36" Storage Cabinet - 24025 SC48 48" Storage Cabinet - 24026



(1) Left door assembly



(1) Right door assembly

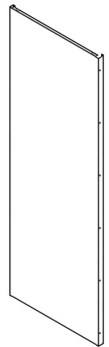

(1) Left side panel

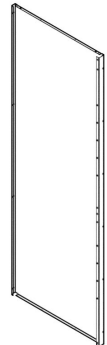

(1) Right side panel

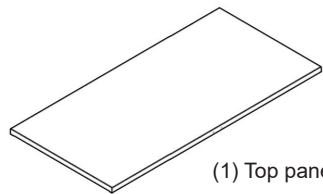

(1) Top panel

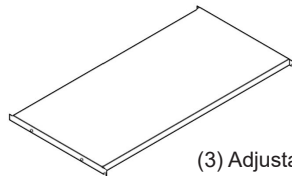

(3) Adjustable shelf

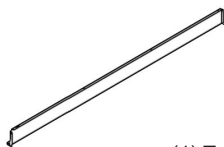

(1) Top rail

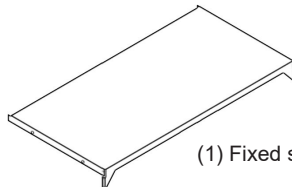

(1) Fixed shelf

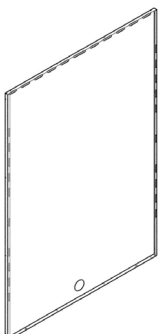

(1) Rear panel

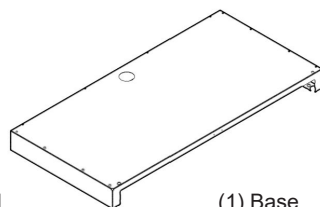

(1) Base assembly

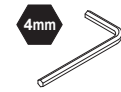

Assembly tip: Do not tighten component fasteners completely until all have been installed. Keeping them loose will help with alignment between parts during assembly.



(4) 0105677
1/2" Cup magnet



(2) 0134543
L-bracket



(4) 021559
Washer

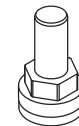

(4) 055194
1/2-13 x 1" Glide

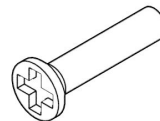

(4) 0105678
4-40 x 1/2"
FHMS



(4) 035712
4mm x 10mm
PHMS



(60) 0100167
8-32 x 1/2" PH
thrd ctg



(4) 0105679
4-40 Locknut



(2) 052605
1/4-20 x 15mm
JC bolt

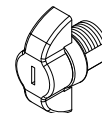

(2) 0108567
Lock



(6) 026064
1/4-20 x 5/8"
PHMS

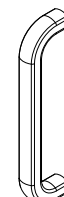

(2) 022316
Handle

1 Attach glides to base

1. Thread on the (4) glides but do not tighten. They can be adjusted later if the floor is uneven.

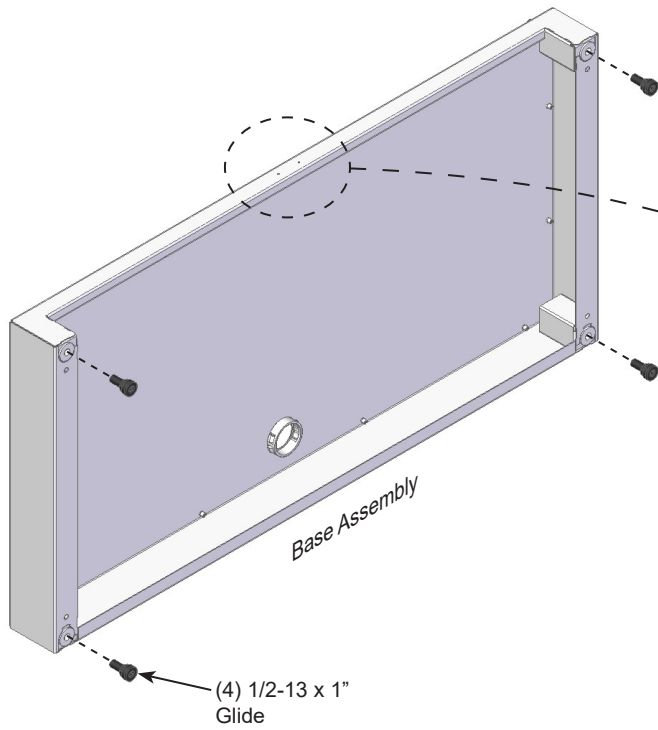

2 Attach magnets to base

1. Attach (2) magnets to the front edge of the base—each with (1) washer, (1) 4-40 x 1/2" FHMS, and (1) 4-40 locknut.
2. Tighten securely.

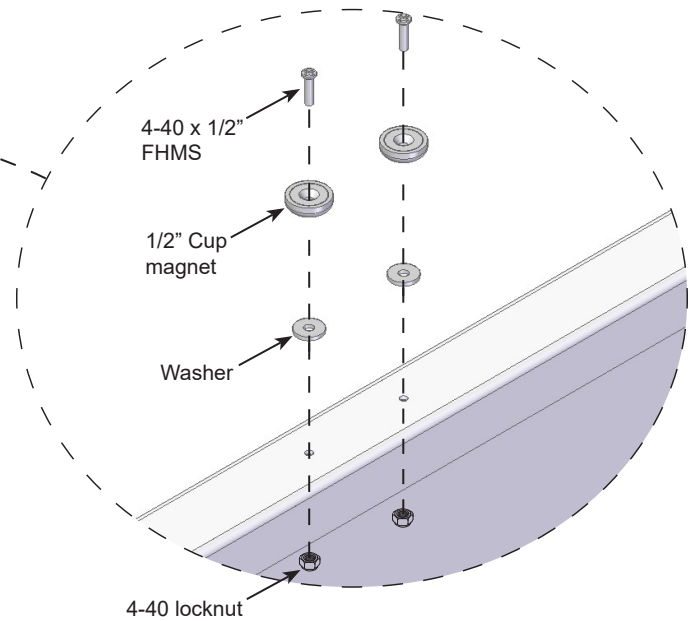

3 Attach rear panel to base

1. Place rear panel (flange-side up) onto a non-abrasive surface.
2. Attach to base with 8-32 x 1/2" PH thrd ctg screws.

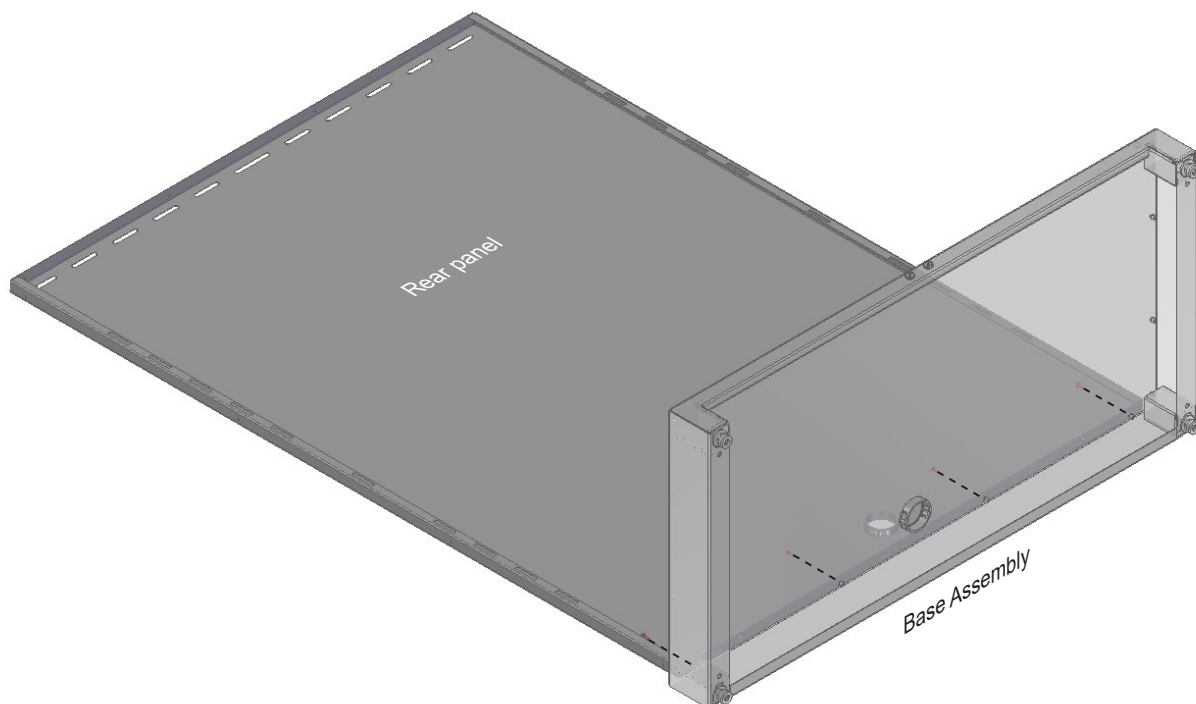

4 Attach side panels

1. Align the left and right panels with the base and rear panel mounting holes.
2. Secure each panel with (8) 8-32 x 1/2" PH thrd ctg screws.

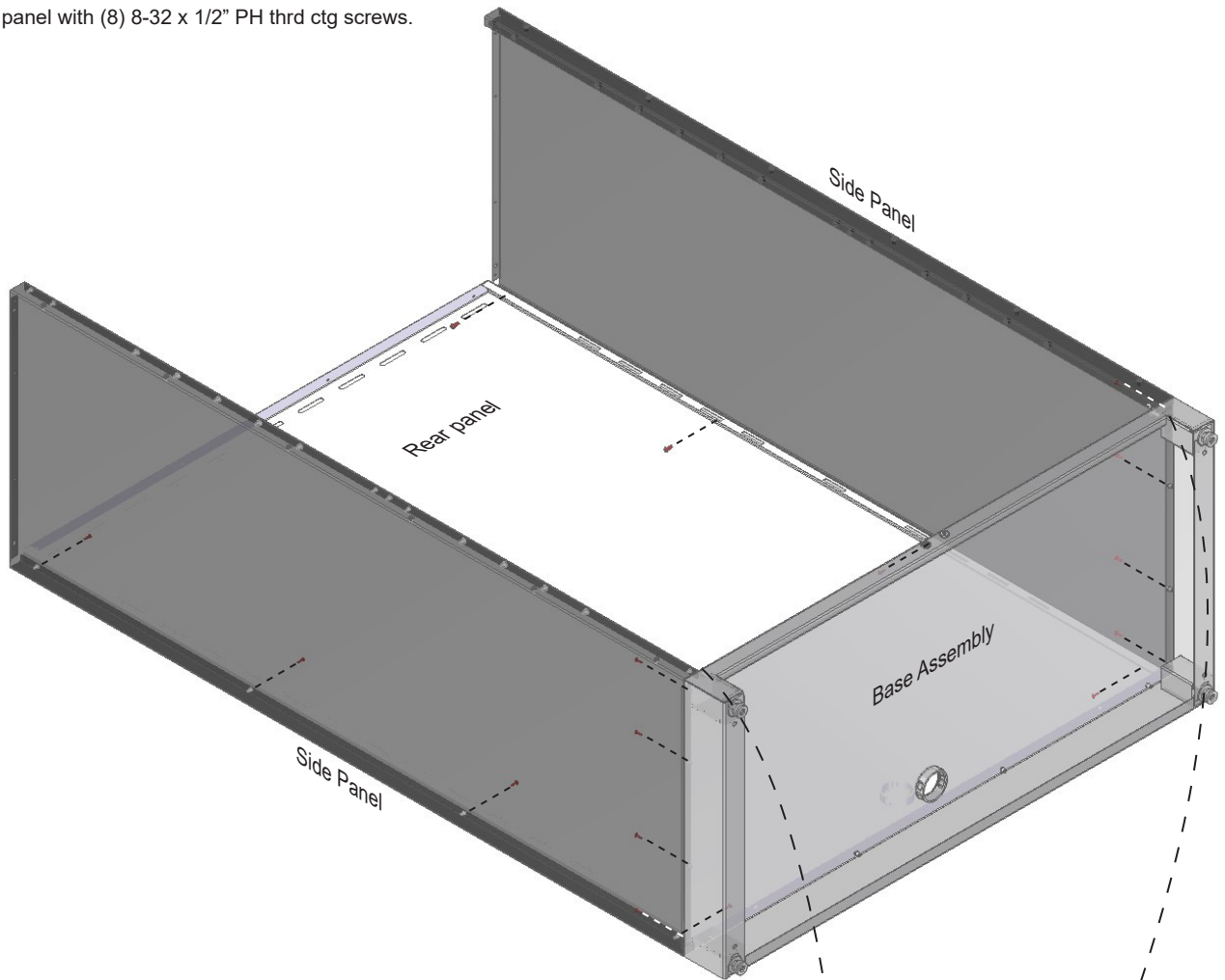

5 Install L-brackets

1. Install (1) L-bracket at the bottom front of each side panel using (1) 8-32 x 1/2" PH thrd ctg screw, and (1) 1/4-20 x 15mm JC bolt.

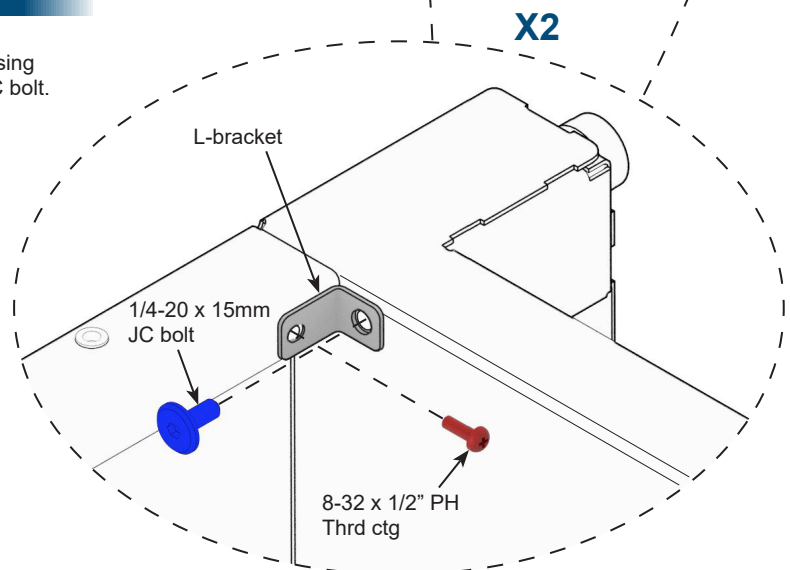

6 Attach top panel

1. Align the top panel with the side panel and rear panel mounting holes.
2. Secure with 8-32 x 1/2" PH thrd ctg screws.

7 Attach magnets to top panel

1. Attach (2) magnets to the front edge of the base—each with (1) washer, (1) 4-40 x 1/2" FHMS, and (1) 4-40 locknut.
2. Tighten securely.

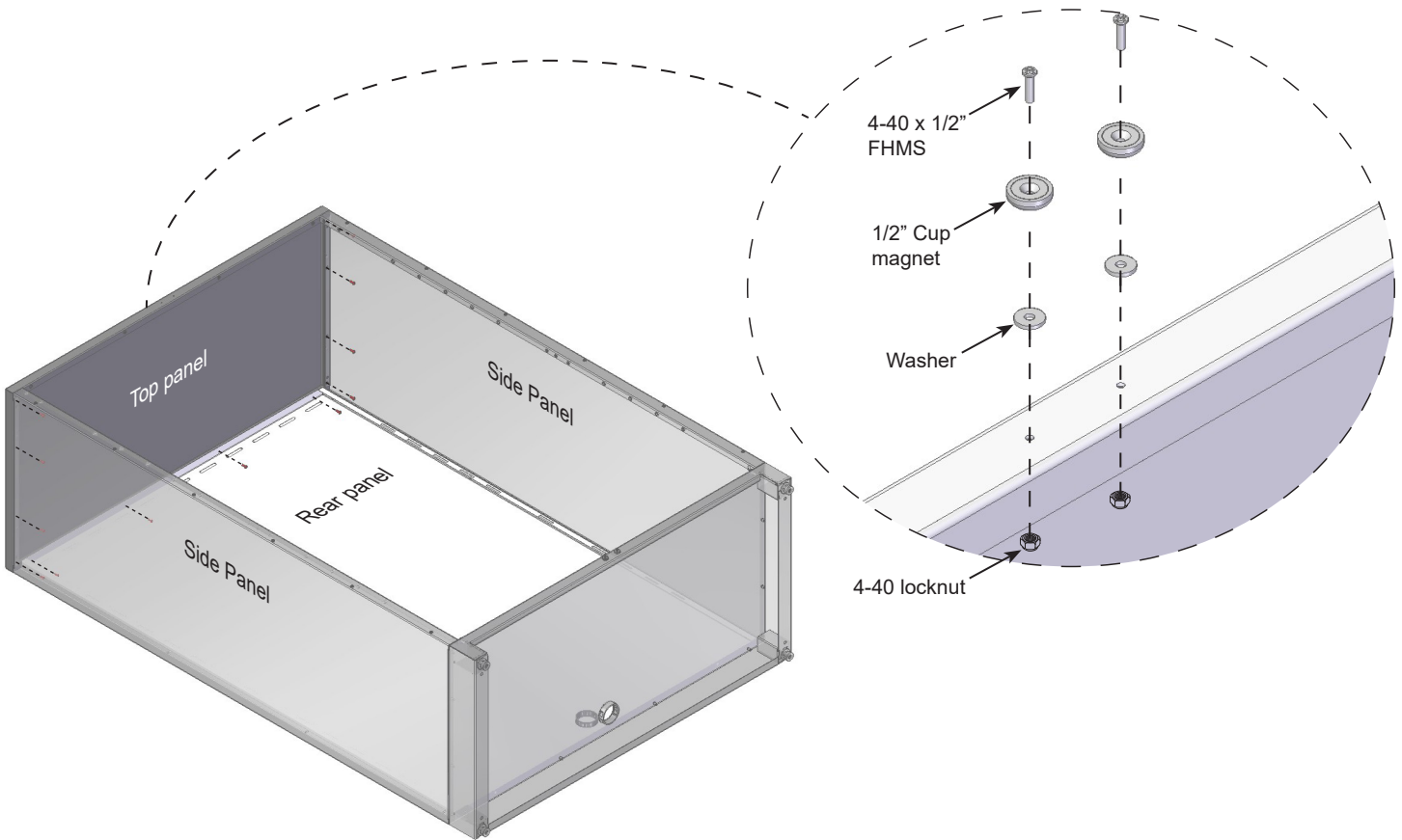

8 Attach top rail

1. Align the top rail with the mounting holes as shown.
2. Secure with 8-32 x 1/2" PH thrd ctg screws.

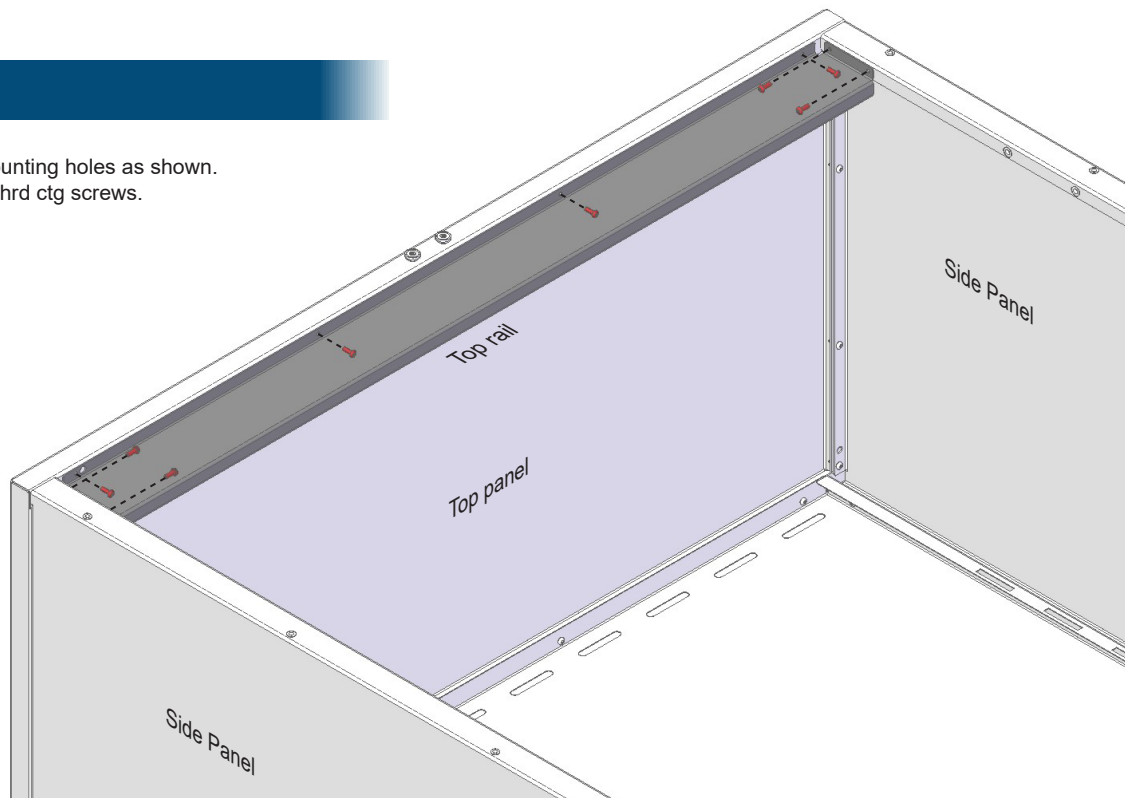

9 Install fixed shelf

1. Install the single fixed shelf at the center of the cabinet using the center rear panel slots.
2. Secure the shelf with (3) 8-32 x 1/2" PH thrd ctg into each side panel.

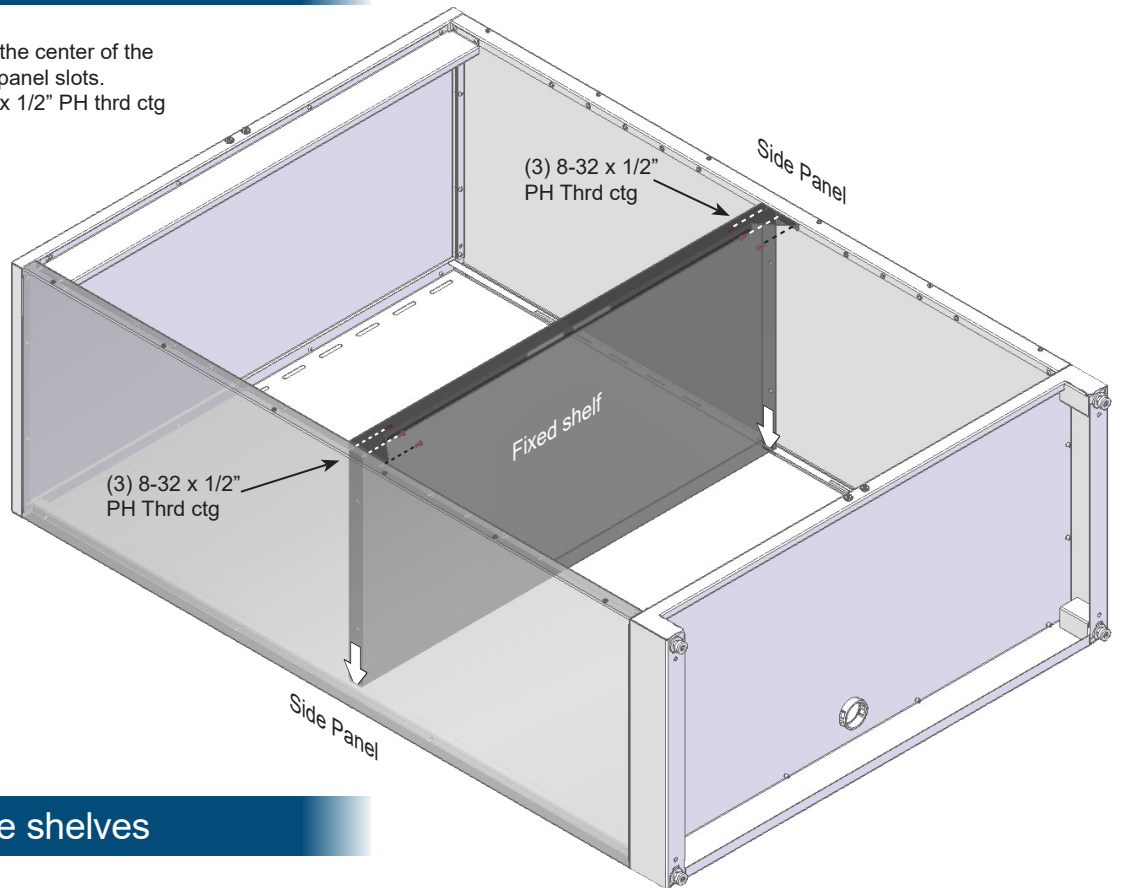

10 Install adjustable shelves

1. Install the (3) adjustable shelves at the heights of your choosing using the rear panel slots and threaded holes in the side panels.
2. Secure each shelf to each side panel with (1) 1/4-20 x 5/8" PHMS and tighten securely.
3. Carefully tip the cabinet up onto the glides. This may take several people.

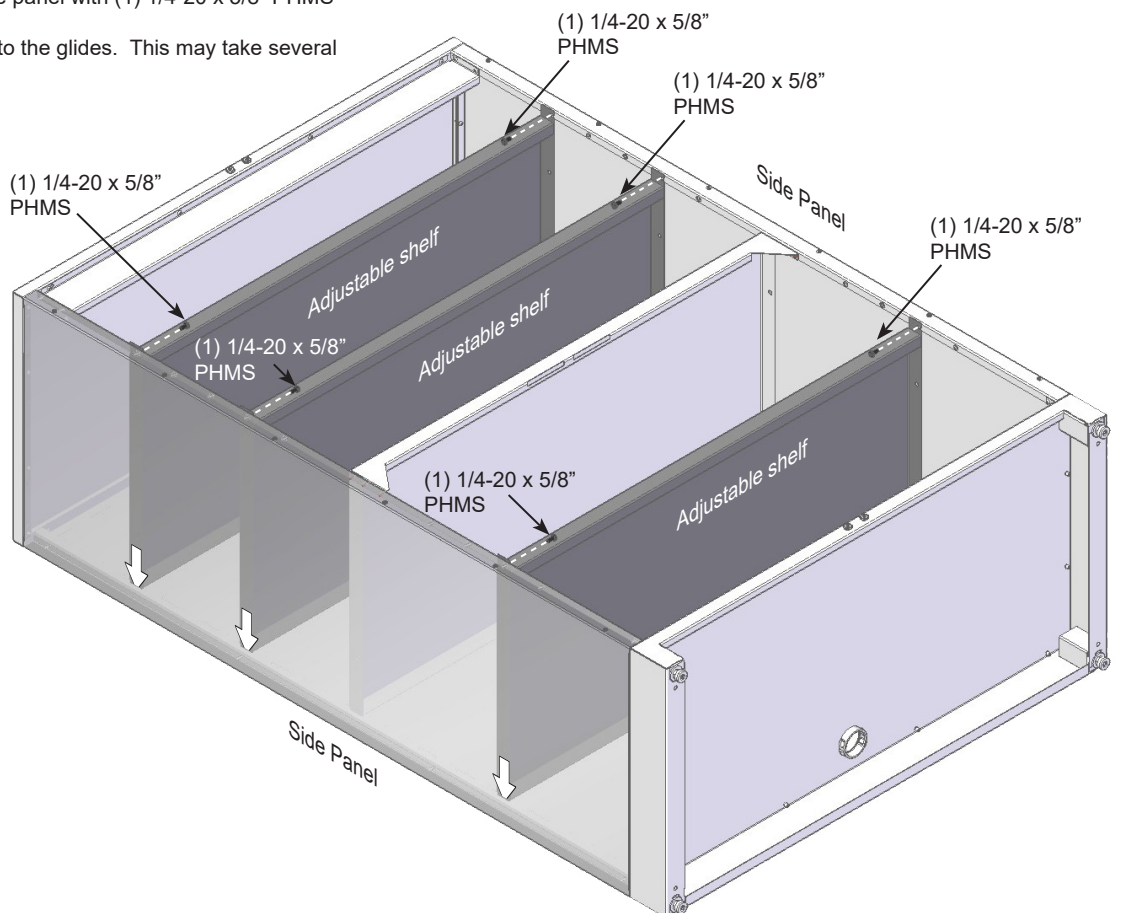

11 Install locks and handles

1. Install a lock into each door as shown and tighten nut securely.
2. Install pawl in vertical orientation to back of lock and secure with included screw.
3. Attach handle with (2) 4mm x 10mm PHMS.

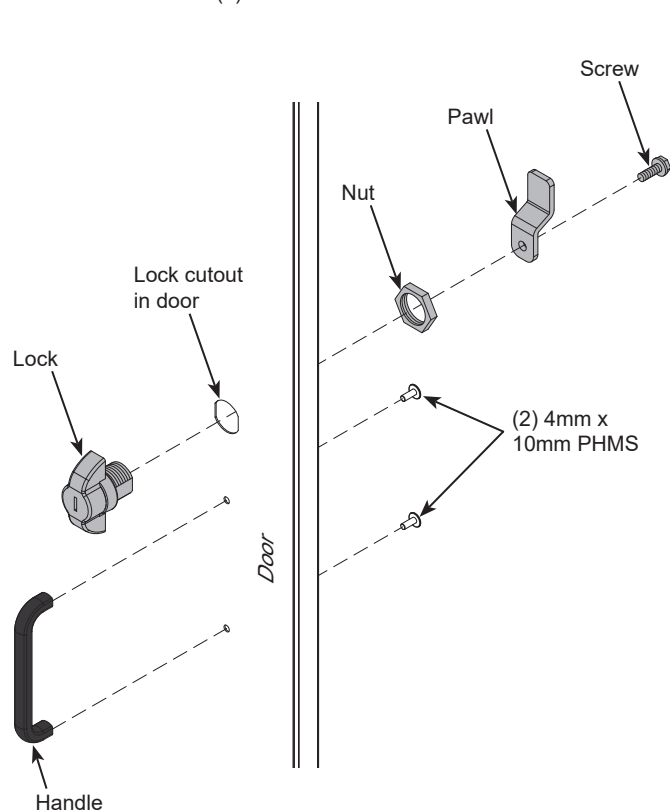

12 Install doors

1. Align door hinge mounting holes with holes in the front edge of the side panel and attach with (6) 8-32 x 1/2" PH thrd ctg screws.
2. Repeat on second door.

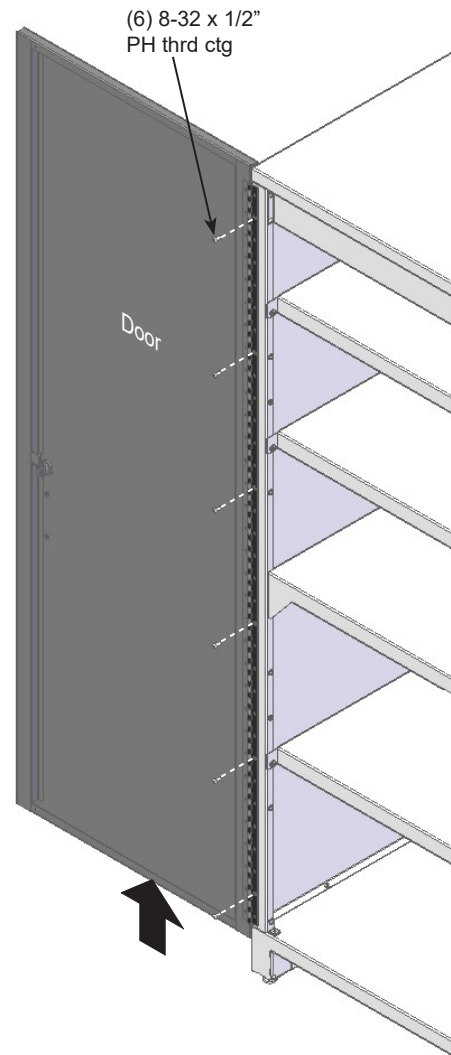

Wall anchoring

Wall anchoring is recommended using the slots provided on the rear panel. Due to the wide variety of wall materials, wall anchor fasteners are **NOT** provided. Individual job conditions as well as state/local building codes will dictate the type of installation fasteners and how the cabinet must be anchored.

