

---

# INSTALLATION INSTRUCTIONS

---

TABLETOP STAND

## **PSD-TTS/C** **PSD-TTS** **PSD-TTS/B**

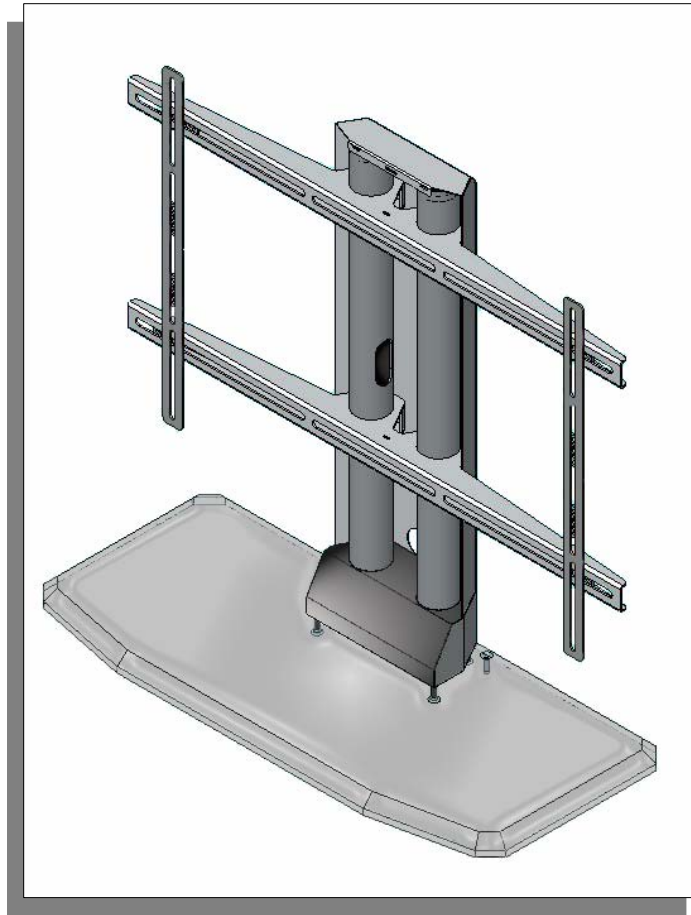

 **PREMIER  
MOUNTS™**  
The original holding company

---

### **NORTH AMERICA**

3130 East Miraloma Avenue  
Anaheim, CA 92806 USA  
USA and Canada –  
Phone: 800-368-9700  
Fax: 800-832-4888

---

### **EUROPE**

Swallow House,  
Shilton Industrial Estate,  
Shilton, Coventry, England CV79JY  
Phone: +44 (0) 2476 614700  
Fax: +44 (0) 2476 614710

---

### **AUSTRALIA, NEW ZEALAND, OCEANIA (Distributor)**

P.O. Box 295  
Mordialloc Victoria 3195  
Australia  
Phone: 03 9586 6330  
[www.premiermounts.com.au](http://www.premiermounts.com.au)

Other Locations – Phone: (001)-714-632-7100; Fax: (001)-714-632-1044

©Premier Mounts 2008

9532-002-001-00



## Contents

- Safety & precautions
- Stand diagrams
- Parts list (1)
- Flat panel list
- Parts list (2)
- Checking the thread depth on your flat panel
- Building the stand
- Securing the mounting brackets
- Securing the flat panel to the stand
- (Optional) fixed installation

## Safety & Precautions



Safety precaution measures must be practiced at all times during the installation of this product. Use proper safety gear and tools for the installations procedure to prevent personal injury or damage to the flat panel display mount.

### WARNING!



The tabletop should be capable of supporting a max weight of 160 Lbs., the weight of the flat panel. More than 160 Lbs the tabletop must be reinforced. Proper installation procedure by qualified personnel as outlined in the installations instructions must be adhered to. Failure to do so could result in serious personal injury.



The entire installation instructions should be fully read and understood, including all of the safety symbols and safety precautions before beginning installation. The installation instructions should be read, understood and followed to prevent personal injury or property damage. Keep these installation instructions in an easily accessible location for future reference.



Indicates that the power plug is to be disconnected from the power outlet.



Contact Premier Mounts for any questions



Safety precautions must be taken at all times.



Warning and caution in general



Do not install near heater, fireplace, direct sunlight or air conditioning or any other source of direct heat energy. Failure to do so may result in damage to the flat panel display and could cause a risk of fire.



At least two qualified people should always perform the installation work. Injury and damage can result from dropping or mishandling the flat panel display.

# Stand diagrams

Dimensions are in Inches and (mm)

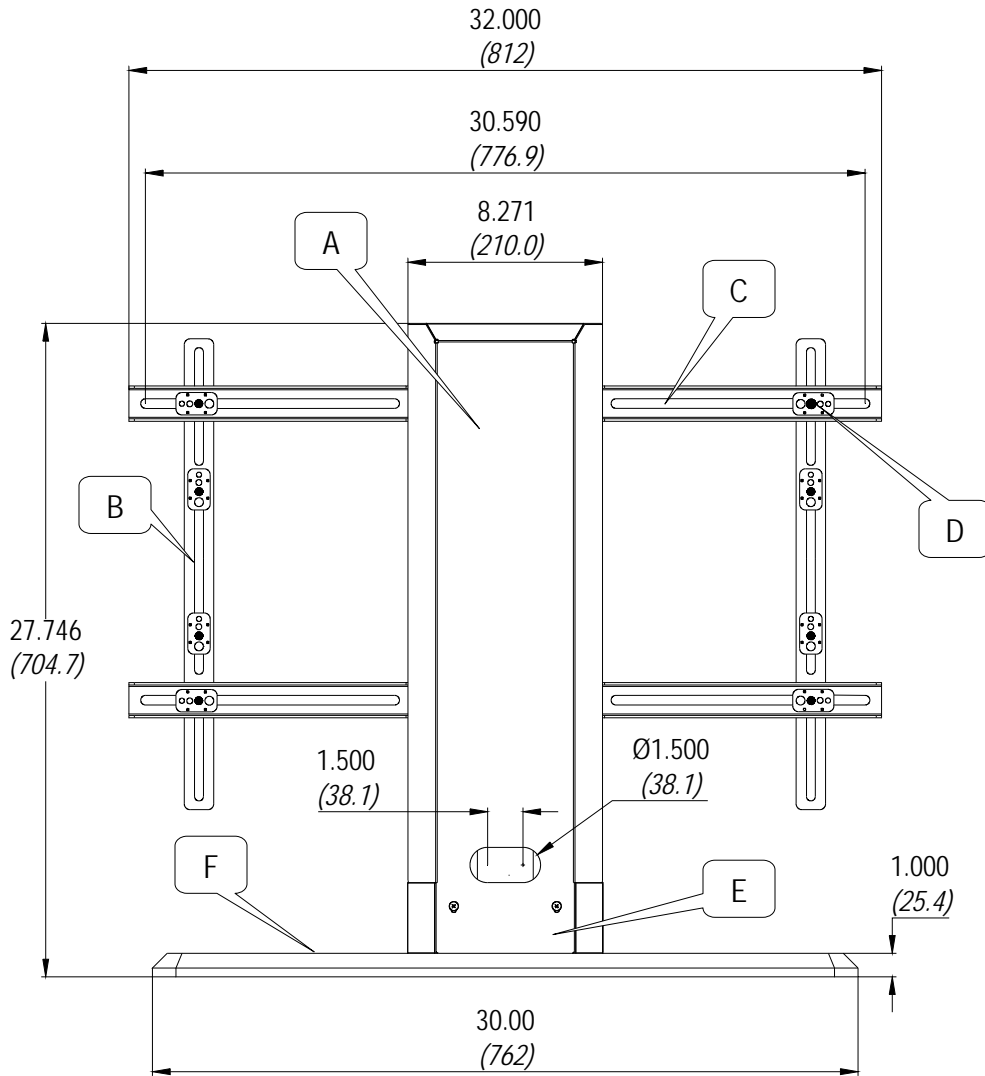

Base dimensions:  
1.00"(25.4) H x 30.00"(762) W x 13.0"(330) D

- PART#:**  
PSD-TTS/C  
PSD-TTS
- COLOR:**  
Silver
- A. Back cover
  - B. Vertical brackets
  - C. Mounting brackets
  - D. Griplates™ & mounting hardware
  - E. Aluminum block
  - F. Base

## Parts list (1)

All of these parts are used to install the mounting bracket. Make sure that none of these parts are missing before beginning installation. If there are parts missing stop the installation and contact Premier Mounts.

Aluminum block (1)

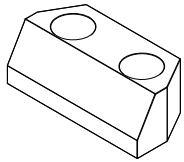

Griplate™ (8)

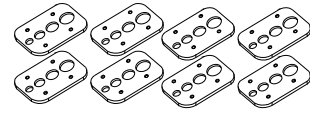

Mounting brackets (2)

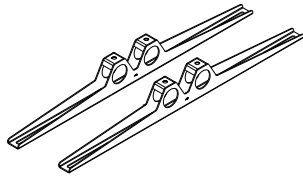

Vertical brackets (2)

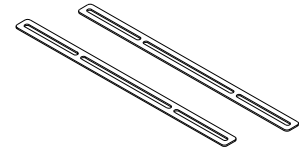

Base (1)

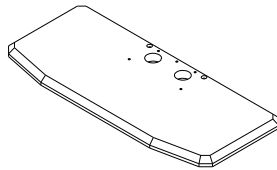

Back cover (1)

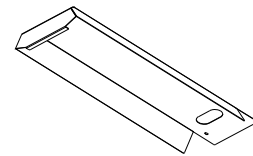

Tubes (2)

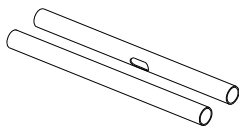

Allen key (1)

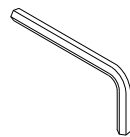

Socket head  
Screws (6)

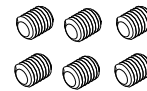

Tube caps (2)



Thread depth  
indicator (1)

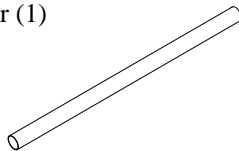

M5 x 10 Phillips  
screws (2)

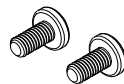

Rubber feet (4)  
(used on the PSD-TTS  
only)



M6 Phillips  
screws (4)

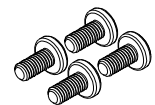

M5 x 30 Phillips  
flat head screws  
(5)

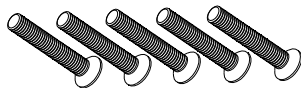

Wood screws  
(2) (Optional  
use)



Rubber vinyl (4)  
(used on the PSD-TTS/C  
only)

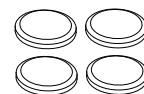

## Flat panel list

<b>Acer</b>	<b>Eizo</b>	<b>Idex</b>
PDP7859: M6 x 20	5420T: M8 x 30	PDM4260: M4 x 16
<b>Akai</b>	<b>Electrograph</b>	<b>Ikegami</b>
CTA42AR7A, PDP4247, PDP4290, PDP4294, PDP5090, HPT500AN: M8 x 25 – ½" nylon spacers - sleeves	DTS42W: M8 x 30 – ¼" nylon spacers (large) DTS4230: M8 x 30 – ½" nylon spacers - sleeves DTS42DD, DTS42GBDD, DTS42GB: M6 x 20	PTM4202: M5 x 20
<b>Akira</b>	<b>Faroudja</b>	<b>Integra</b>
EPM420, SV4201: M5 x 16	FPP42HD10, FPP50HD10: M4 X 16	PLA50V1: M4 X 16
<b>Albatron</b>	<b>Fujitsu</b>	<b>JVC</b>
PWW46AC: M6 x 20	4211, 4212, 4221, 4222, 4208, 4209, 4213, 4214, 4229, 4241, 4242, 4233: M5 x 16 5001, 5002, 5003, 5004, P50XHA10, P50XCA11UH, P50XHA30WS: M8 x 25 – flat washers	GDV4200PZW, 4210, GDV4210PZWGA, 4211, GMP420UG, GMV42UG, JVP042WV74, PD42WV74, PD42WX84: M5 x 16 GDV500PZU, GDV501U, 502U: M8 X 30 – ½" nylon spacers – sleeves
<b>Barco</b>	<b>Gateway</b>	<b>LG Electronics</b>
Cineversum 50: M8 x 20 Solaris LC40: 8 x 30	GTWP42M102: M8 x 20, M8 x 35 – ¼" nylon spacers (large) GATEWAY 42: M8 x 30 – ¼" nylon spacers GATEWAY 46: M6 x 20 GATEWAY 50: M8 x 30 – ¼" nylon spacers	Flatron MU40PA10B, MU40PA15B: M5 x 20- ¼" nylon spacers Flatron MN42PZ10, MN42PZ11, MU42PZ10, MU42PZ11B, MU42PZ15B: M5 x 20 MU50PZ41, MU50PZ90: M5 x 20
<b>BenQ</b>	<b>Helios</b>	<b>Luce</b>
PDP7843E: M6 x 20 – ¼" nylon spacers (small) PDP46W1: M6 X 16	4200: M8 x 20	PDTV4220A: M5 x 25 – ½" nylon spacers
<b>Cornea</b>	<b>Hitachi</b>	<b>Marantz</b>
MP4200, MP4204: M5 x 16	32HDT20, CMP307XJ, CMP307XU, 32HDT20 CMP401HDU, CMP402HDE, CMP402HDU, CMP4120HDU, CMP4121, CMP4121HDU, CMP4201U, CMP4202U, 42HDW10, 42HDT20, 42HDT50, 42HDT55 M6 x 16 CMP5000WXU, CMP5003WXU, 50HDT50, 50HDT55: M8 X 20 32HDT20, 32HDT50, 32HDT55, 32HDX60: M6 x 16	PD4280D, PD4282D, PD4290D, PD4292D, PD4293: M4 x 20 PD4298HD: M6 X 20 PD5010D, PD5020, PD5040:
<b>Dream Vision</b>		<b>Max</b>
Revolution One, Revolution Five: M4 x 16		4600, 4600T: M6 x 20 5000: M8 x 30- ½" nylon spacers - sleeves
<b>Dukane</b>		
P37: M6 x 16 P42: M6 x 16 P50: M8 x 20		
<b>Dwin</b>		
HD50: M8 x 30 – ½" nylon spacers - sleeves		
<b>EIKI</b>		
PLD42XU: M5 x 20 - ¼" nylon spacers (small) PLD32: M4 x 20		



### Note

If your flat panel display is not listed, go to (page 10) to determine the thread pitch on your flat panel.

<b>Mitsubishi</b>	<b>Pioneer</b>	<b>SONY</b>
PD5010HD, PD5030: M4 x 16	PDPV401, V402, PDP4330HD, PDP433HDE, PDP433CMX, PDP433PU, PDP4300, PDP4340HD, PRO800HD, PRO800HDI, PRO910HD, PDP4310, PDP501X, V502MX, V502X, PDP503MX, V505, PDP505HD, PRO1000HD, PDP503CMX, PDP5030HD, PDP503HDE, PDP5031HD, PDP5040HD, PRO1000HDI, PRO1110HD: M8 X 20	PFM42B1, PFM42B2: M6 x 20 - 5/16" flat washers PFM-42V1, PFM-42V2: M6 x 20 - 5/16" flat washers PFM50C1: M6 x 20 - 5/16" flat washers KE-42XBR900: M6 x 20 - 5/16" flat washers KE50XBR900: M6 x 20 - 5/16" flat washers KE42XS910: M6 x 20 - 5/16" flat washers KLV-30XBR900, KLV30MR1, LDM3000 KE32TS2U, KZ32TS1, PFM32C1, KE37XS910: M5 X 16 5/16" flat washer
<b>Monivision</b>	<b>Princeton Graphics</b>	<b>SVA</b>
PWW46AC, PD46W00: M6 x 20 PD3231, LWX30AMS: M6 x 16	AR3.4FTW, AR4.6PDP: M6 x 20	HD4208TIII: M6 x 20 - 1/4" nylon spacers
<b>NEC</b>	<b>Rainbow</b>	<b>Tatung</b>
4200W, 4210W, M4A, MP2, PX42M3A, 42PD1W, PD2 M5A, M5G, 42MP1, 42PD1, PX42VM1A, PX42VP1A, PX42VP2A, 42MP3, 42PD3, PX42VP3A, 42MP4, 42VP4A, 42MX2: M4 X 16, 5000W, PX50M5A, 50PD1, PX50VP1A, PX50MX1A, 50MP1, 50MP2, 50PD2, 50VP2, 50MP3, 50XM3: M4 X 16	Spectrum 3750: M6 x 20	P46T: M6 x 20
<b>Norcent</b>	<b>RCA</b>	<b>Toshiba</b>
46WGA850: M6 x 16	PR42300, PHD42600, PHD50300, PHD50400: M4 X 16 PHD50500: M8 X 20	42HP82: M4 X 16 PD42W, PD42W1: M8 X 30 - 1/2" nylon spacers (large) - sleeves 50HP81: M8 X 30 - 1/2" nylon spacers (large) - sleeves 50HP82: M4 X 16
<b>Orion</b>	<b>Revox</b>	<b>Trex</b>
PM4202: M5 x 16	E1042: M6 x 20 E1050: M8 x 20	TXP4600: M6 x 20
<b>Panasonic</b>	<b>Runco</b>	<b>V-Inc</b>
TC42P1, PT42PD3P, PT42PD1P, TC42P1F, PT37P1, TH42PWD3, TH37PWD4UZ, PT37PD4, TH37PW5EX, TH37PA20UP, TH42PD4UY, TH42PWD4EX, PT42P1, 42PD2, TH42PWD3U, TH42PHD5U, PT42PD3P, PT42PD4, PT42PHD4P, TH42PWD5UY, TH42PW5UZ, TH42PWD6UY, TH42PA20UP, TH42PL20E, TH42PAX20, TH50PHD3U, PT50PD3P, PT50PHD4P, TH50PHD3E, TH50PHW3, TH50PD4, TH50PHD5UY, TH50PHD6UY, TH50PL20E, TH50TX20UP: M8 X 30 - 1/2" Nylon spacers - sleeves TH42PX20U, TH50PX20U: M8 X 70 - 1-1/2" Nylon spacers TC-32LH1: 4 x 25 - 1/2" Nylon spacers	PL42C, CW42: M4 X 16 PL42CXPL50CX: M8 X 30, 1/2" Nylon spacers - sleeves E1050, PL50C, PL50HDX, CW50MC: M8 X 20	Vizio P1, Vizio P4: M6 x 16
<b>Philips</b>	<b>Sampo</b>	<b>Vidikron</b>
42FD9934, 42FD9952, 42FD9954, 42PH9555, 42FD9935: M5 x 25 1/2" Nylon spacers BDS4611: M6 x 20 50FD9934/17S: M4 X 16 34PW9847, 30PW8859, 30PW8879, 30PW8869, 30PW9817, 34W9817, 37FD9954, 32FD9954, 32PF9954, 32PH995S, 30PF9975: M5 x 25 - 1/2" Nylon spacers	PME42S6: M8 x 30 - 1/4" nylon spacers (large) PME42F61: M8 x 20, M8 x 35 - 1/4" nylon spacers (large) PME50X6: M8 x 30 - 1/4" nylon spacers (large)	VPW420: M8 X 30, 1/2" Nylon spacers (large) - sleeves
<b>Planar</b>	<b>Samsung</b>	<b>VIEWSONIC</b>
42N: M4 x 16 50P: M8 x 20	PPM42S2, PPM42S3, SPL4225K, SPN4235, SPN4239: M8 x 25 - 1/2" nylon spacers SPK4215M, PK42P2S: M8 x 25 - 1/2" nylon spacers PPM50H2, HPL5025K: M8 x 30 - 1/2" Nylon spacers - sleeves PPM50H3, HPN5039: M8 x 25 - 1/2" nylon spacers	VPW420: M8 x 30 - 1/2" nylon spacers - sleeves VPW425: M8 x 30 - 1/4" nylon spacers (large) VPW450HD: M8 x 30 - 1/4" nylon spacers (large) VPW500: M8 X 20 VPW505: M8 x 30 - 1/4" nylon spacers (large)
	<b>Sanyo</b>	<b>Yamaha</b>
	PDP421A: M5 x 20 - 1/4" nylon spacer (small) PDP42H1NA: M5 x 20 - 1/4" nylon spacer (small) PDP32H1A: M5 x 20 - Nylon spacers	PDM1: M8 x 30 - 1/2" nylon spacers - sleeves
	<b>Sharp</b>	<b>Zenith</b>
	PZ42H2U, PZ43HV2U, PD50U, PZ50HV2U: M8 X 20	DPDP40W, P40V22, DPDP40V, P40V24: M5 x 20 - 1/4" nylon spacers (small) P42W22, P42W22B, P42W24P, P42W34P: P40V24: M5 x 20 - 1/4" nylon spacers (small) P50W26, P50W28, P50W38: M5 x 16

 **Note** If your flat panel display is not listed, go to (page 9) to determine the thread pitch on your flat panel.

## Parts list (2)





**Note** This wall mount is shipped with all proper installation hardware and components. Make sure that none of these parts are missing before beginning installation. If there are parts missing stop the installation and contact Premier Mounts.

### Actual screw size

M4 x 16  (Qty 8)

M4 x 25  (Qty 4)

M5 x 16  (Qty 8)

M5 x 20  (Qty 6)

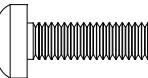
M5 x 25  (Qty 4)

M5 x 50  (Qty 4)

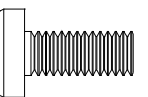
M6 x 16  (Qty 8)

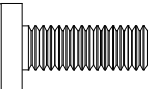
M6 x 20  (Qty 6)

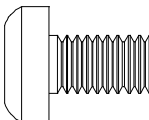
M8 x 20  (Qty 6)

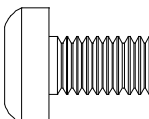
M8 x 25  (Qty 6)

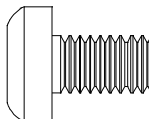
M8 x 30  (Qty 6)

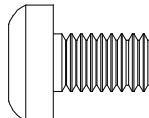
M8 x 35  (Qty 4)

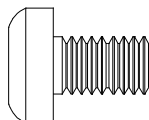
M8 x 70  (Qty 4)

**Nylon spacers and flat washers**



**Note** The nylon spacers may be stacked to achieve proper spacing.

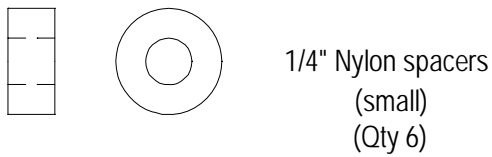
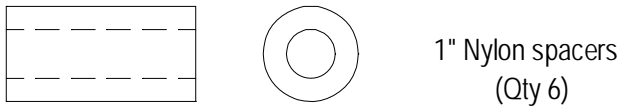
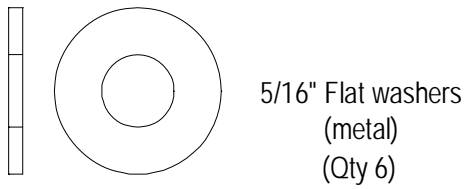
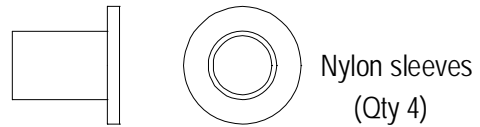
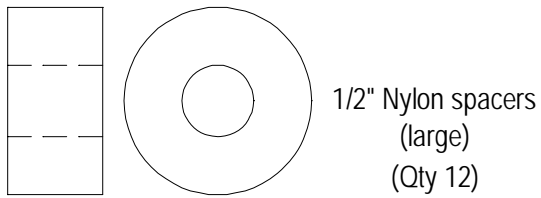
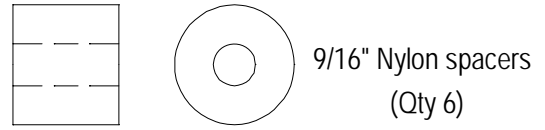
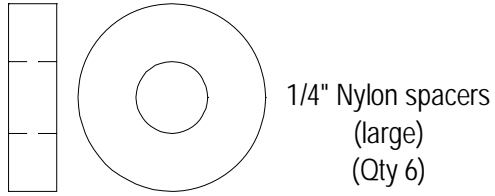



## Checking the thread depth on your flat panel

1. Insert the thread depth indicator (supplied) through the thread inserts found on the back of the flat panel to make sure the inserts measure the same full depth and mark it. (see figure 1)
2. Locate the correct diameter screw for the thread insert. Compare your marking to the screws (supplied). If your selected screw is longer than the marking on the thread depth indicator **DO NOT USE** this screw.
3. The screw length must not bypass the marking. Select another screw size (see figure 2 and 3). Until you find one that comes closest to your mark without going past.

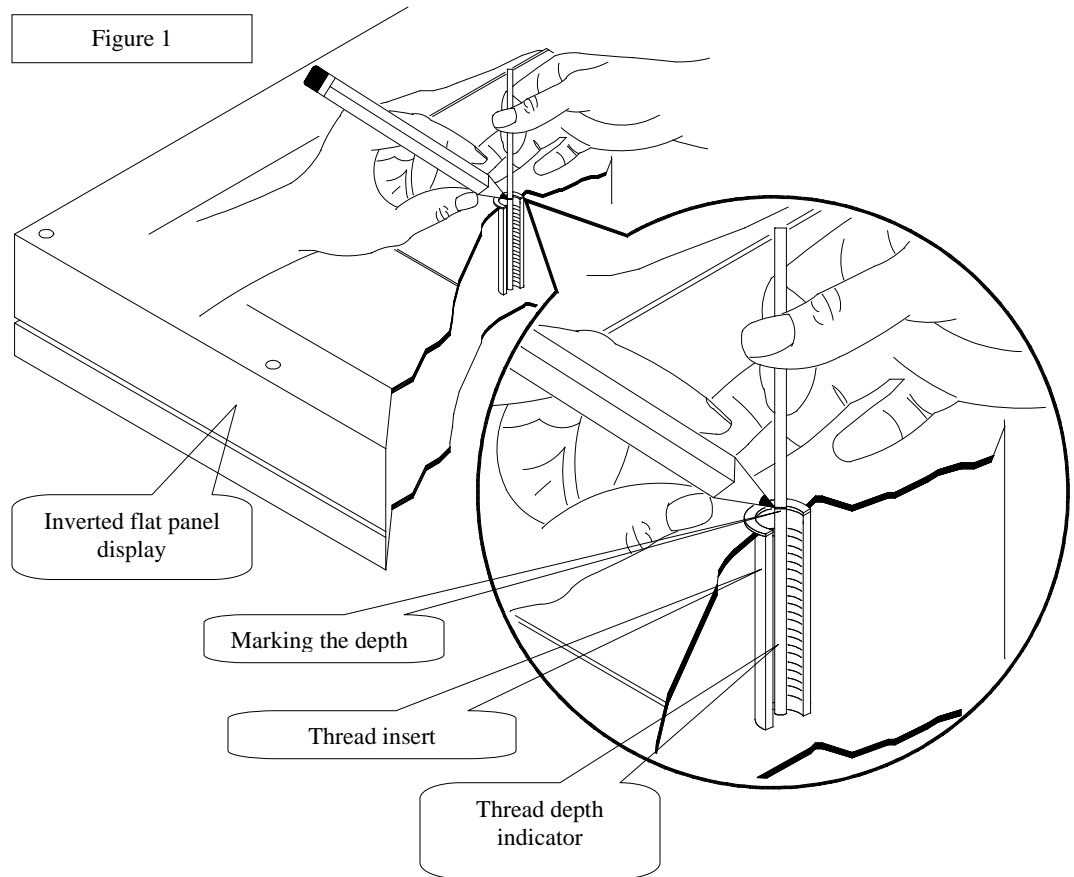

Figure 2

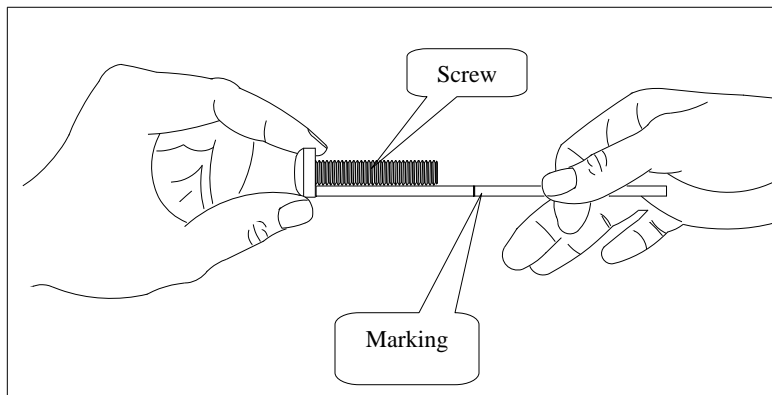
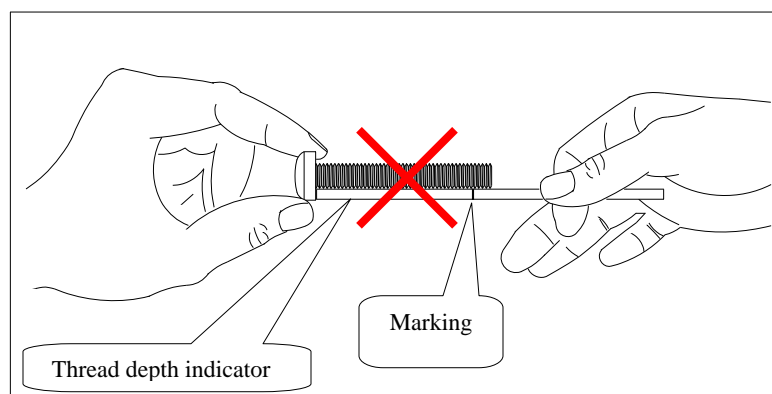

Figure 3



## Building the stand

### Step 1

Unpack the components from the box and set them on the floor. Invert and secure the rubber vinyl or rubber feet depending on model to the bottom of the base. Secure the aluminum block to the base as shown in (figure 1) to the base by using the five (5) M5 x 30 (mm) Phillip flat head screws (supplied). See figure 1.



**Caution**

Do not over tighten the screws. Find a suitable location for the stand.

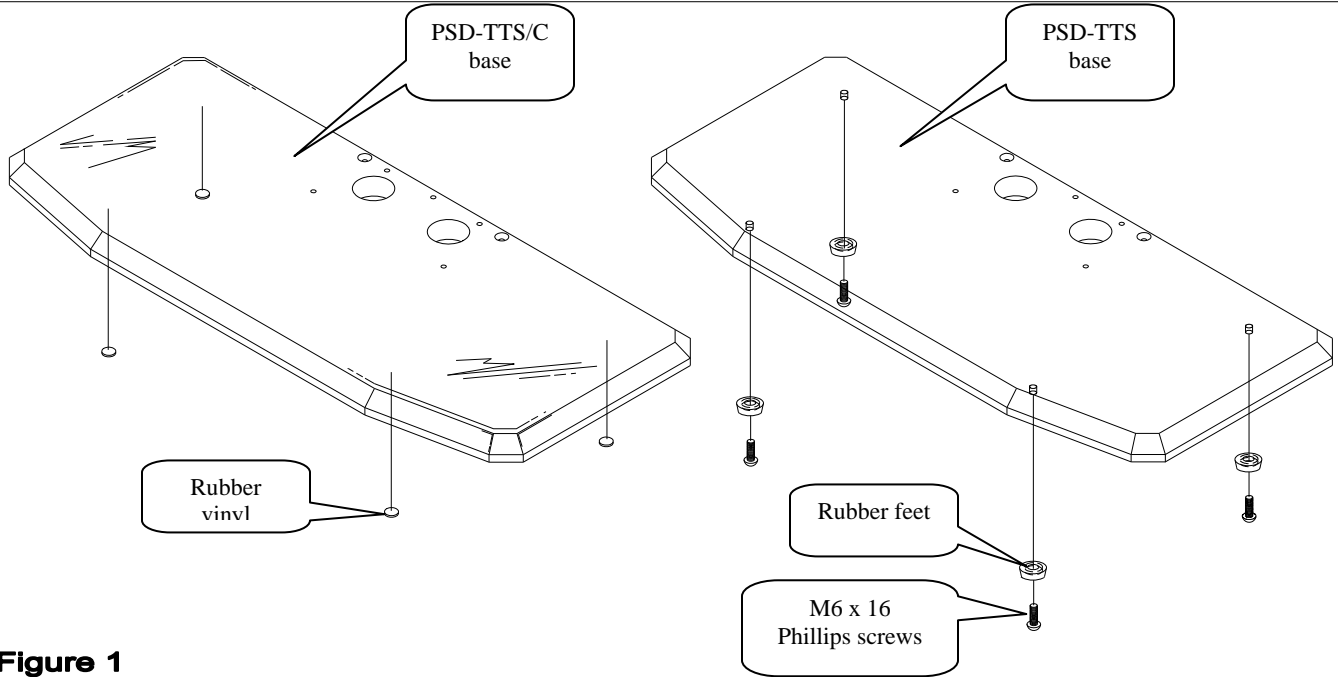

**Figure 1**

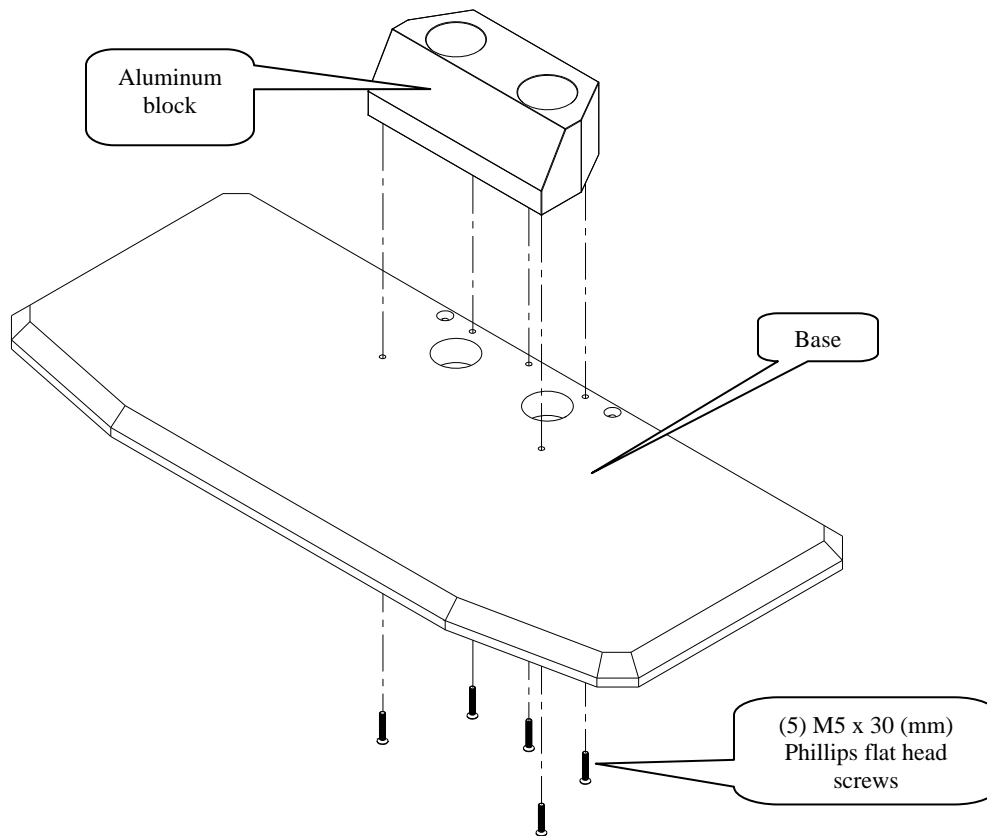

**Step 2**

Insert the tubes into the secured aluminum block. See diagram to set the cable access openings before tightening the set screws. See figure A. Once the poles are fully inserted into the block and set to their proper positions lock the tubes by tightening the two

**Figure 2**

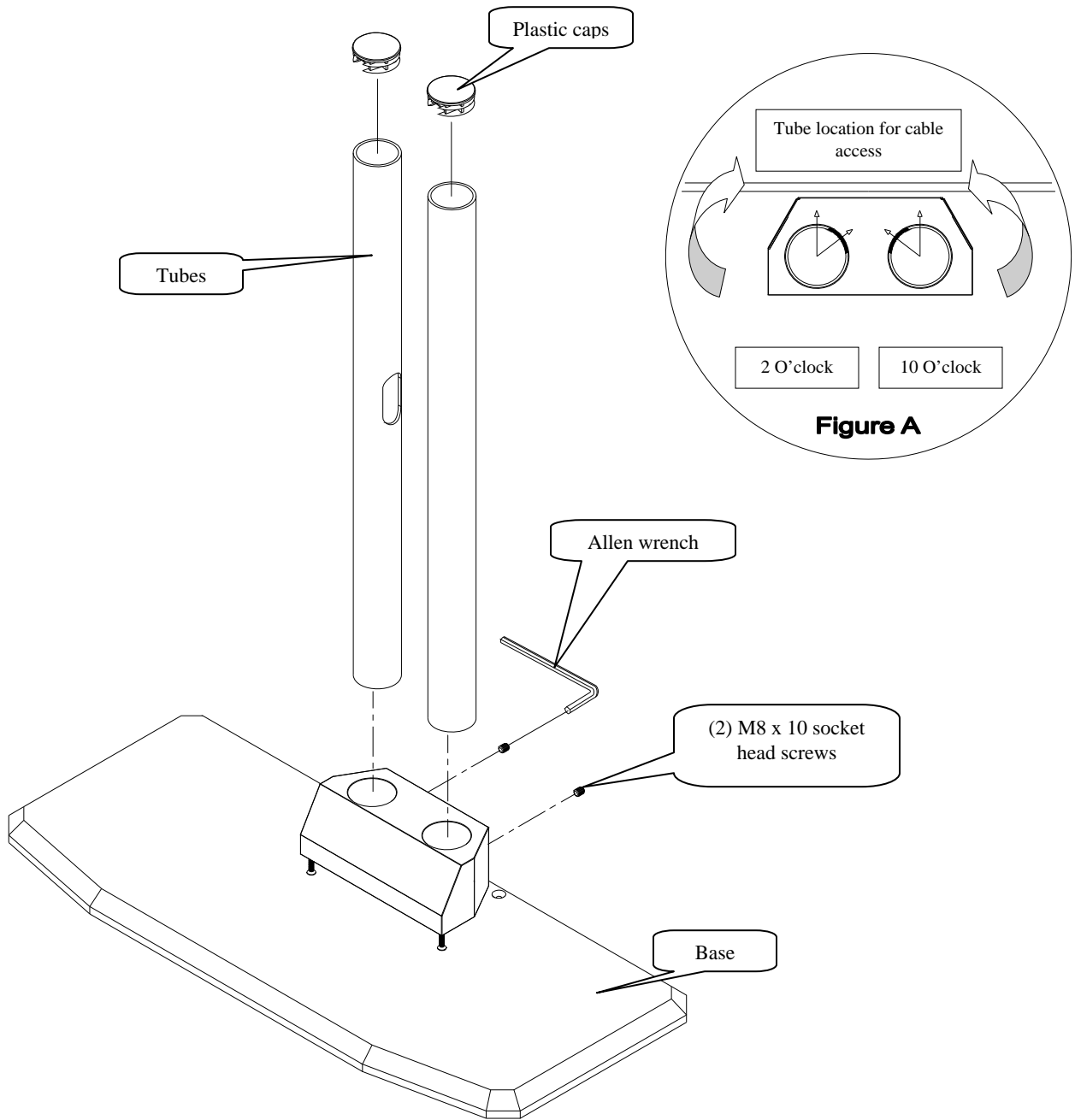

## Securing the mounting brackets

### Step 3

Invert the flat panel display and lay it on a soft and flat surface. Apply the vertical brackets and center the mounting brackets from left to right on the display. Secure the mounting brackets with the hardware and griplates™ (supplied). NOTE: The griplates™ come with an M4,M5,M6 and M8 access holes. Find out what your proper hardware for your flat panel will be and use accordingly.

**Figure 3**

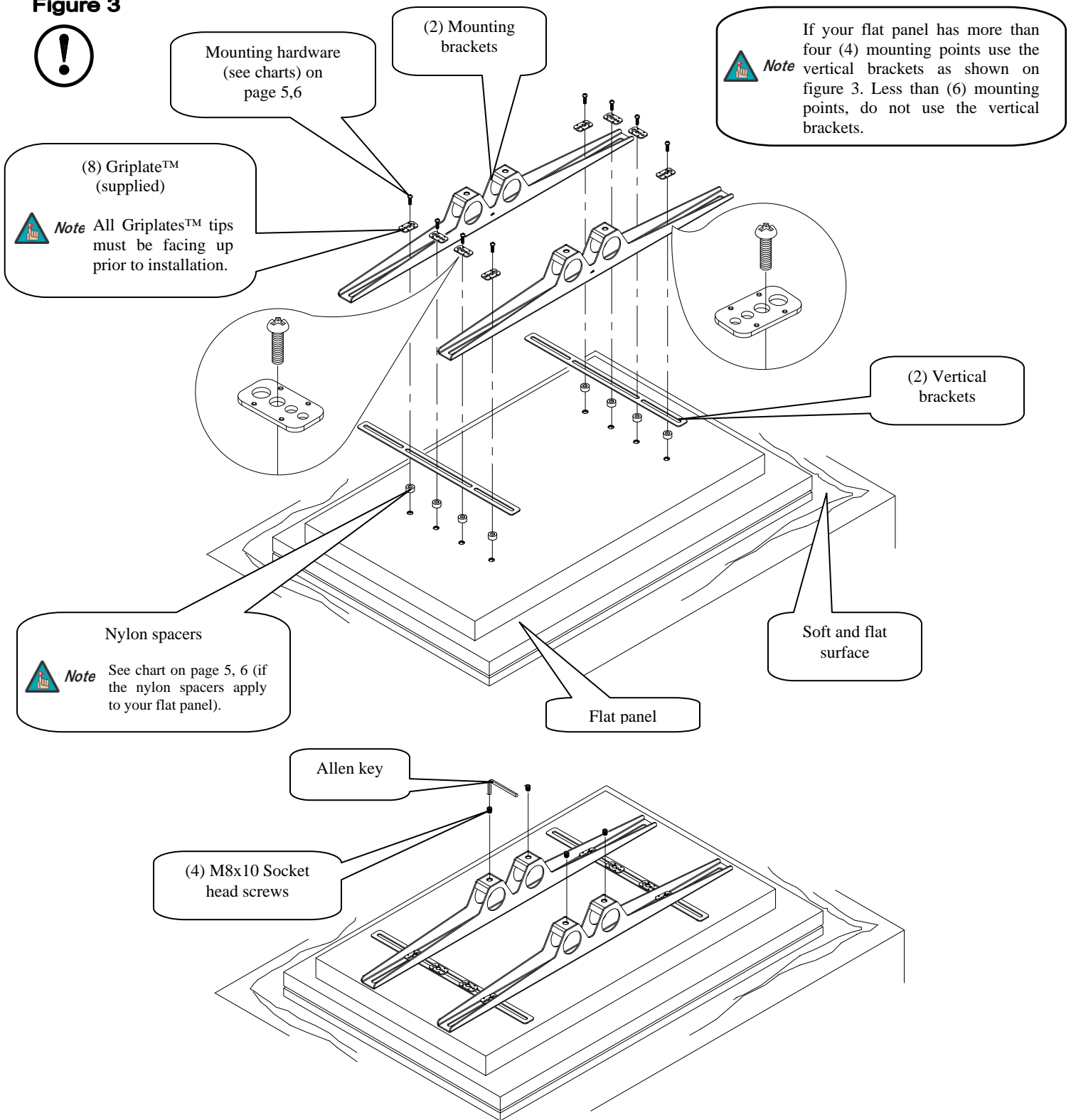

## Securing the flat panel to the stand

### Step 4

Raise the display (see warning on this page) and slide the mounting brackets over the tubes, set the height required and using the Allen wrench secure the height by tightening the four (4) M8 socket head screws. **Do not over tighten the screws.** Make all proper connections at this time. Install the back cover plate and secure it using two (2) M5 x 10 phillips screws (supplied). See figure 4.

Figure 4

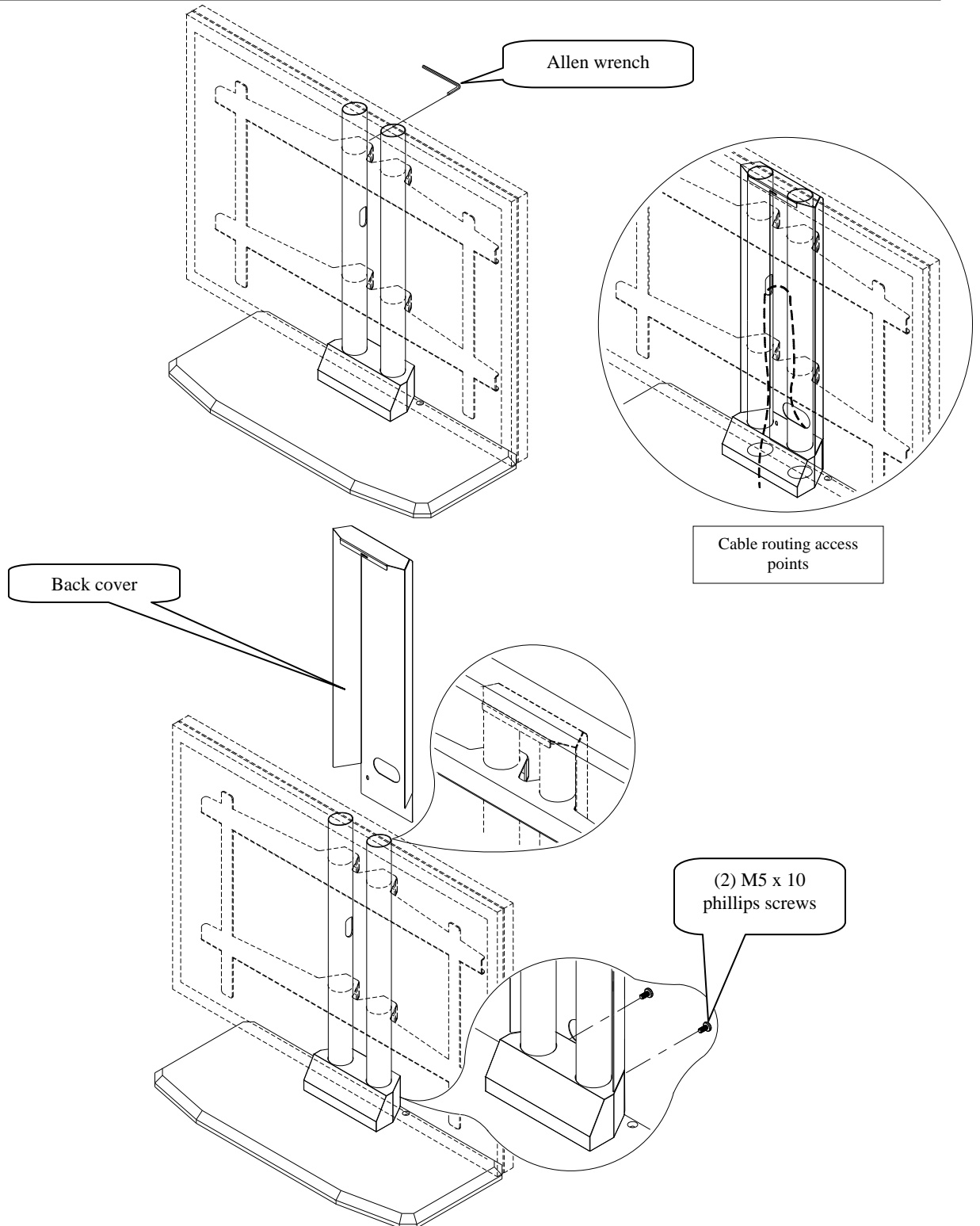

AT LEAST (2) QUALIFIED PERSONNEL ARE STRONGLY RECOMMENDED FOR INSTALLATION OF THIS PRODUCT. FAILURE TO DO SO COULD RESULT IN SERIOUS INJURY AND POSSIBLE DAMAGE TO THE FLAT PANEL.

## (Optional) fixed installation

### Step 5

If securing to a wood table, secure the stand with the two (2) #10 x 1-3/4" wood screws (supplied).



**Note** Longer or shorter wood screws and or mounting hardware depending on your installation environment are (commercially available). See figure 5.

**Figure 5**

