

Assembly Instructions

⚠ Important ⚠

Before you begin, read and comply with all safety and operating instructions, and ensure all parts and correct quantities are included.

Any parts damaged during shipment must be reported within 5 days of receipt. To report information regarding missing parts or damage, to purchase parts or accessories, or if you have any questions, please contact us.





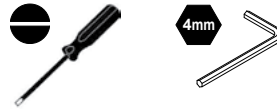





www.spectrumfurniture.com
800-235-1262, 715-723-6750

Thank you for purchasing Spectrum products!

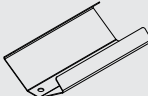

LED Lighting Kit for Esports Desks

37362 - (1 desk)	37365 - (6 desks)
37363 - (3 desks)	37366 - (10 desks)
37364 - (5 desks)	37367 - (16 desks)

37362 - (1 desk)	37363 - (3 desks)	37364 - (5 desks)	37365 - (6 desks)	37366 - (10 desks)	37367 - (16 desks)	PART#	ITEM
1	1	1	1	1	1	0192177	4-Pin Connector 
1	1	1	1	1	1	0192178	6" Driver adapter 
1	1	1	1	1	1	0192179	12 volt power supply 
1	1	1	1	1	1	0192180	12" RGB F to M cable link 
1	3	5	6	10	16	0192181	Plus shape connector 
1	1	1	1	1	1	0192182	LED Controller & RF Remote 
-	2	4	5	9	15	0192183	72" Interconnection cable 
1	3	5	6	10	16	0192272	6" Interconnection cable 
1	3	5	6	10	16	0192184	12" RGB LED Tape light 
1	3	5	6	10	16	0156657	LED Light bracket 
2	6	10	12	20	32	0101911	#14 x 3/4" PHSM 

1 Remove covers from LED controller

1. Using a micro flat head screwdriver, remove the two plastic covers from the controller.



2 Connect driver adapter wires

1. With the power unplugged, place the driver adapter power wires into the selected slots.
2. Tighten securely.



3 Connect RGB wires to controller

1. Place the RGB wires from the 12" RGB F to M cable link into the selected slots.
2. Tighten securely.

4 Connect and test LED's

1. Connect the LED components as shown and make sure both tape strips light up.

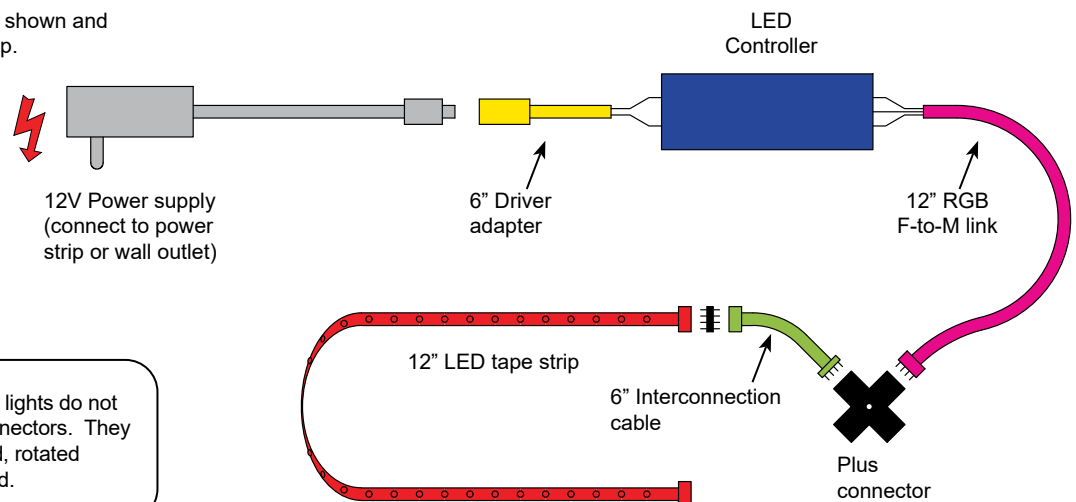

Assembly tip: If the LED tape lights do not light up, check polarity of connectors. They may need to be disconnected, rotated 180-degrees and reconnected.

5 Apply LED tape to bracket

1. Apply the 12" LED tape strip to the bracket flanges with the connectors pointing toward the cord channel.

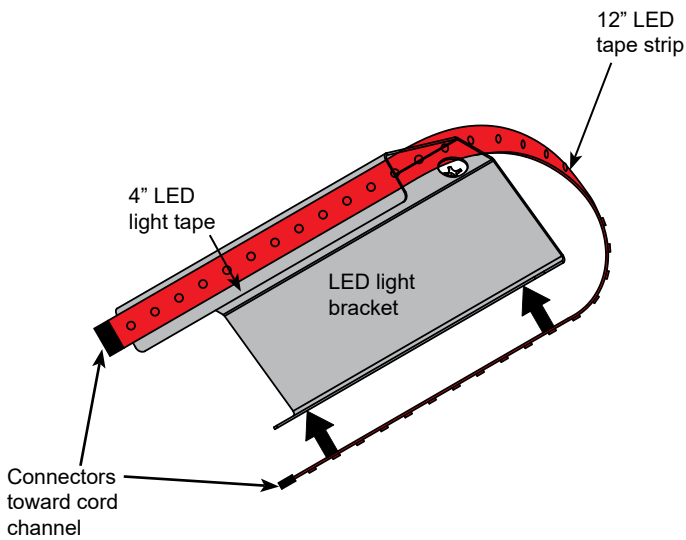

6 Attach LED light bracket

1. Attach the LED light bracket centered under the worksurface with (2) #14 x 3/4" PHSM screws.

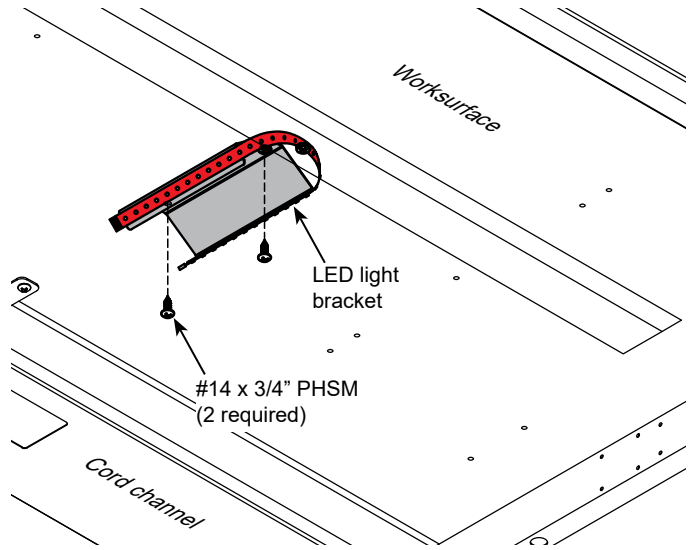

7 Connect LED components

1. Connect the components under the worksurface as shown while routing them through the desk cord channel.
(Note plus connector and LED tape will not go in the cord channel.)

