

## Technical Specifications

Small
One-piece panel only (p.5) - 96511

Compatible with:  
• Inspiration Plus Lectern - 55411

Medium
One-piece panel (p.5) - 96504
Two-piece "split" panels (shown above) (p.3) (2 required) - 96512

Compatible with:  
• Freedom XRS Elite Lectern - 55289  
• MM Series - Compact Lectern - 55212  
• MM Series - Link Lectern - 55115

Large
One-piece panel (p.5) - 96507
Two-piece "split" panels (shown above) (p.3) (2 required) - 96513

Compatible with:  
• Freedom One eLift Lectern - 55357  
• Honors Lectern - 55178  
• Media Manager Elite Lectern - 55258

XL
One-piece panel (p.5) - 96510
Two-piece "split" panels (shown above) (p.3) (2 required) - 96514

Compatible with:  
• MM Series - Director Lectern - 55213

Panels available for standard Spectrum overbridges provide the ability to easily mount presentation controllers and other devices. Flexible, modular design simplifies adaptation to technology changes or upgrades.

## Features and Benefits

- Modular design provides easy lectern customization using interchangeable panels with common standard cutouts
- One or two-piece panels available
- Symmetrical panels are easily removable with two screws and can be rotated 180° to place cutouts on left or right-side
- Connector bracket easily joins two-piece panels together
- Blank panels can be used for custom cutouts
- Scratch, impact, fingerprint-resistant, high-pressure textured laminate face
- 2" grommet(s) for cord pass-through
- Includes installation hardware
- Warranted to be free of all defects in materials and workmanship for 10 years
- Designed and assembled in Chippewa Falls, WI, USA

Note: While some panels may work with older Spectrum "legacy" products, Spectrum only recommends using these panels with the specific compatible products listed above.

## Construction

- Overbridge panels are constructed from 3/4" thick NAF (no added formaldehyde) composite board with .030" [.762mm] high-pressure textured laminate (standard black) on one face, and a balancing phenolic backer on the opposing face
- Connector bracket is 16-gauge steel finished with a scratch-resistant powder coat epoxy

Note: Overbridge panels with standard cutouts have been designed for many of the currently available devices on the market. Custom cutouts are available, but should be reviewed by Spectrum to ensure clearance of brackets, keyboard slides, or other objects under the worksurface.

### Contact Spectrum to specify cutout size(s) and location(s).

Cutouts can be made in the blank insert panel by the customer after the lectern has been purchased, but are only recommended within the maximum cutout areas shown.

## 2-piece "split" panels







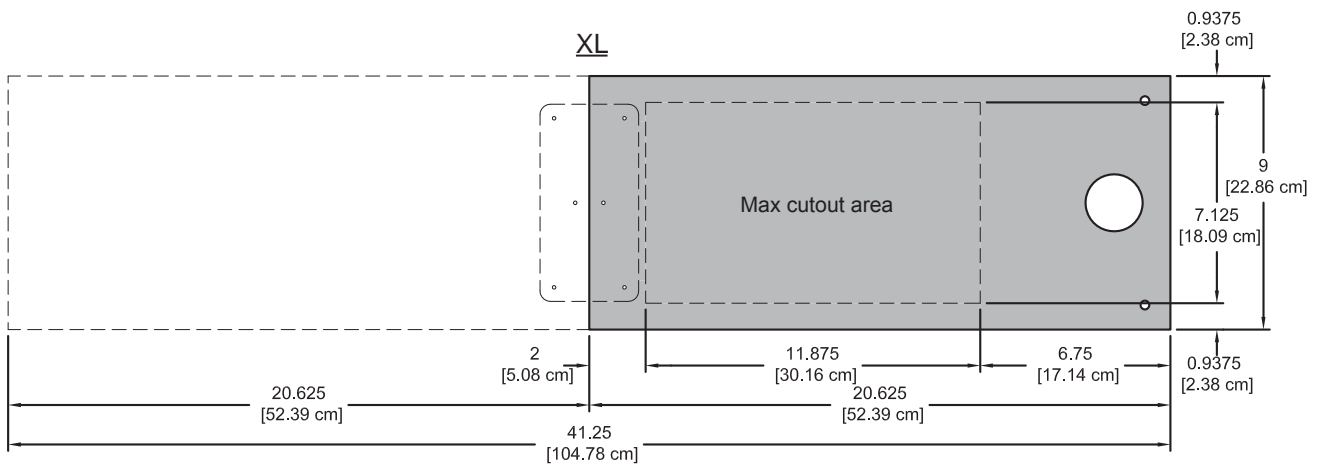
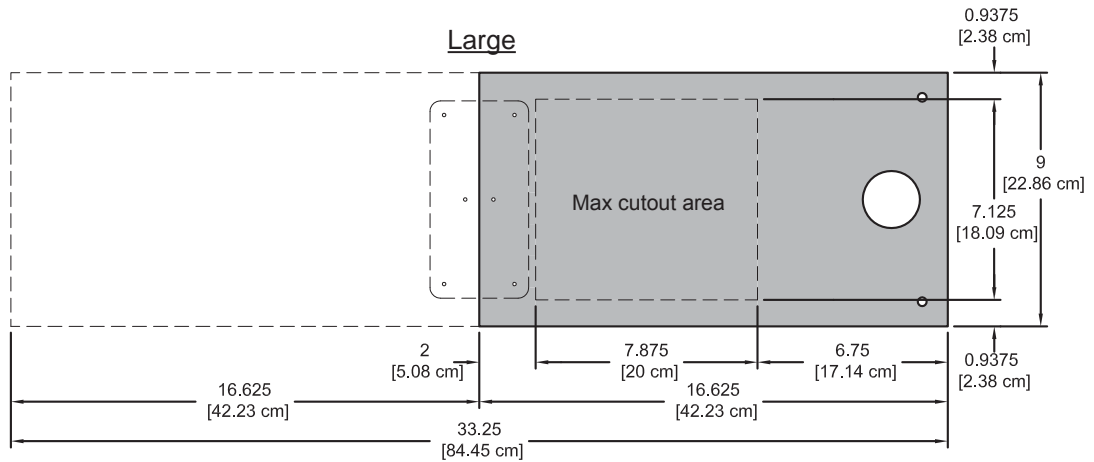
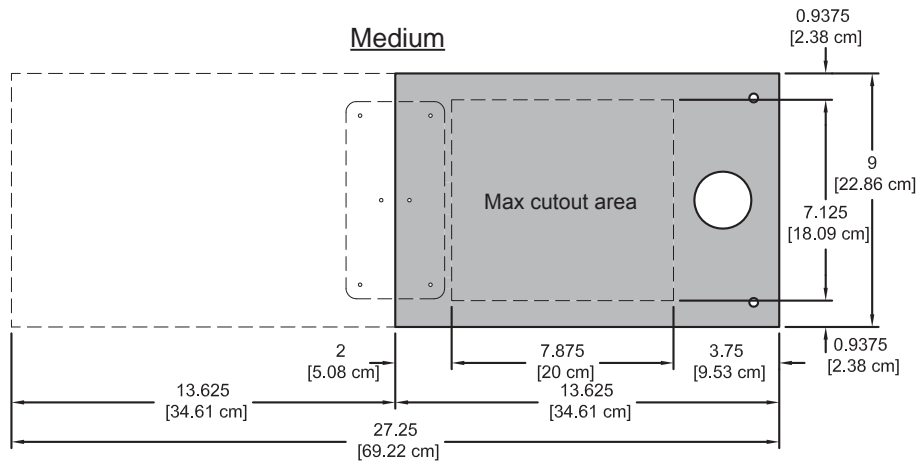
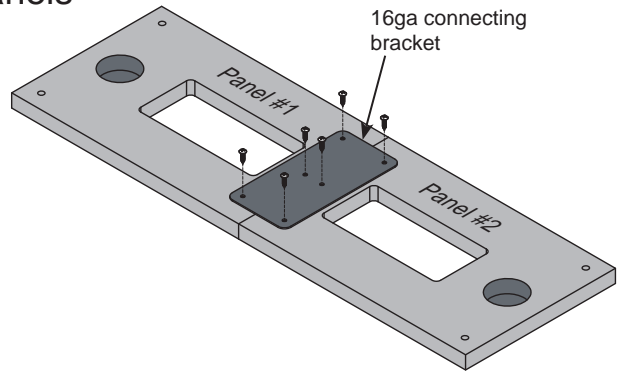































2-piece panels are used when:

- one or more cutouts are needed
- frequent device changes or upgrades are anticipated

Note: Symmetrical panels are easily removable with two screws and can be rotated 180° to place cutouts on left or right-side.



## Two-piece "split" panels (standard cutouts available)

Device	Cutout Size (in.)		Overbridge Size			
	L X W ↔ ↓		Medium - 96512 (1 of 2)	Large - 96513 (1 of 2)	XL - 96514 (1 of 2)	
Misc	Blank		 0120387	 0120388	 0120389	
	Power Module (new) <i>Power module included &amp; installed on configured lecterns only. Power module <u>not</u> included with replacement panels.</i>	5.65 x 1.65	 0143848	 0143859	 0143867	
	Cove Module <i>Cove module included &amp; installed on configured lecterns only. Cove module <u>not</u> included with replacement panels.</i>	5.25 x 2	 0120703	 0120714	 0120725	
Extron	Cable Cubby 202	7 x 3.25	 0120693	 0120704	 0120715	
	Cable Cubby 500	5.75 x 5.75	 0120694	 0120705	 0120716	
	Cable Cubby 700	7.125 x 5.75	 0120695	 0120706	 0120717	
	TLP 350MV	5.781 x 3.875	 0120696	 0120707	 0120718	
	TLP Pro 320M	5.51 x 3.82	 0120697	 0120708	 0120719	
	TLP Pro 520M					
	TLP Pro 720M	7.5 x 5.813	 0120698	 0120709	 0120720	
	MLC226 IP	5.4 x 2.9	 0120699	 0120710	 0120721	
	MLC226 IP DV+	9.375 x 3.875	 0120700	 0120711	 0120722	
	MLC226 IP AAP					
	AAP 104	7.25 x 2.93	 0120701	 0120712	 0120723	
	Crestron	TSW-750 TSW-752 TSW-760	TSW-1050 TSW-1052 TSW-1060	3.567 x 2.375	 0120702	 0120713

# 1-piece panels







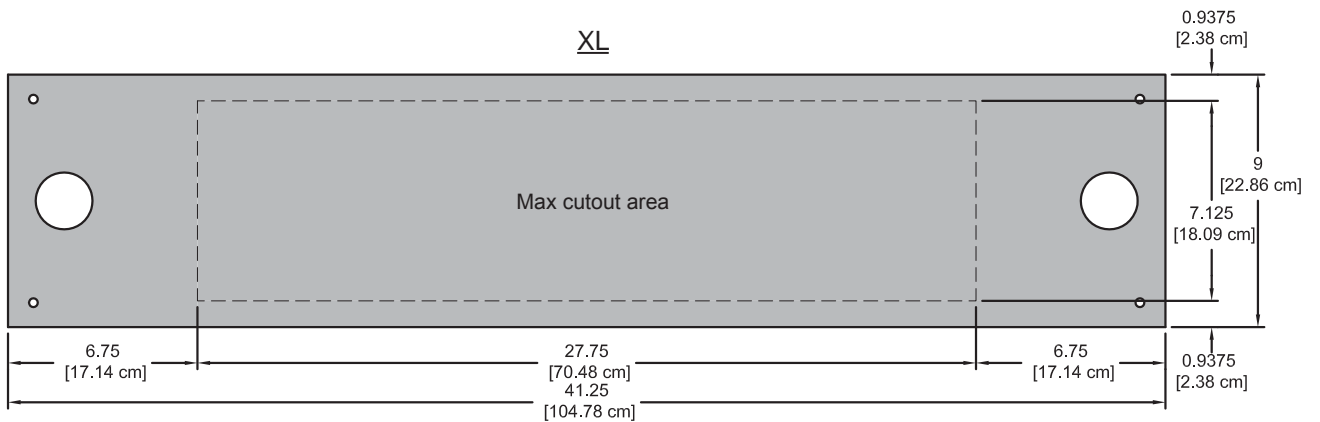
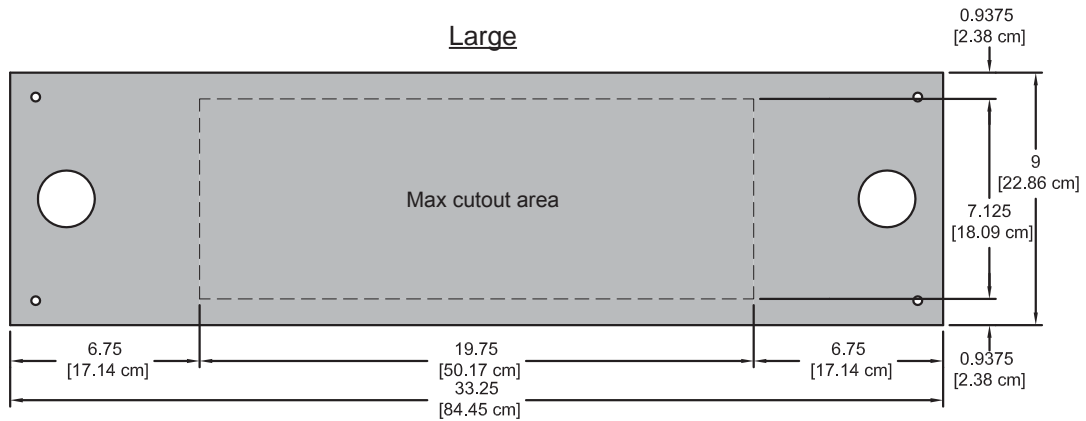
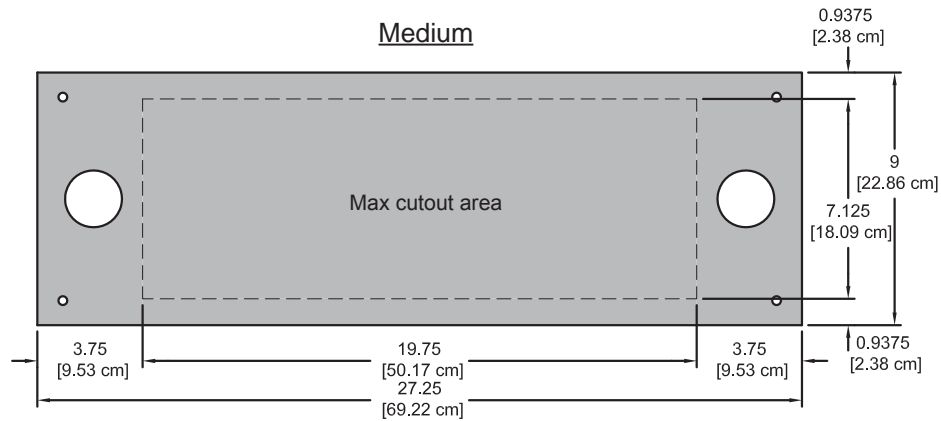
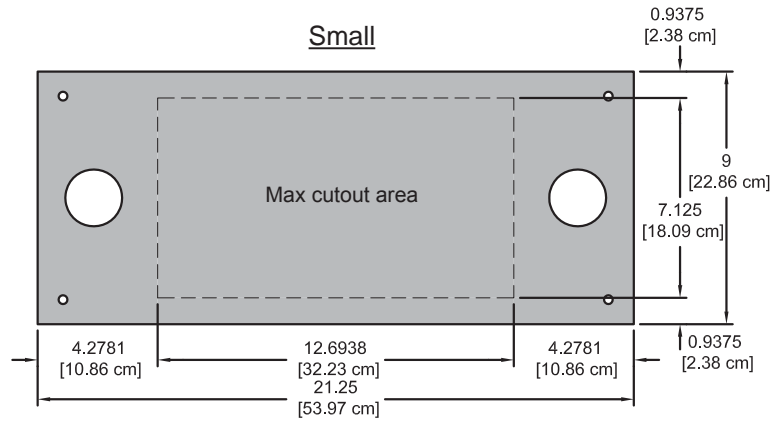





A 1-piece panel is used when:

- one or more cutouts are needed
- a larger (wider) cutout is needed
- a centered cutout is needed
- a cutout will interfere with the connecting bracket on a 2-piece overbridge panel

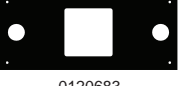
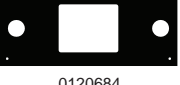
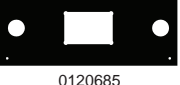
Note: Symmetrical panels are easily removable with two screws and can be rotated 180° to place cutouts on left or right-side.

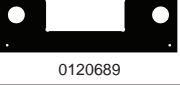
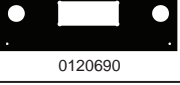

# One-piece panels (standard cutouts available)

Device	Cutout Size (in.)		Overbridge Size			
	L X W ↔ ↓		Small - 96511 (1-piece panel)	Medium - 96504 (1-piece panel)	Large - 96507 (1-piece panel)	XL - 96510 (1-piece panel)
Misc	Blank		 (96501) 0113093	 (96504) 0113504	 (96507) 0113457	 (96510) 0119976
	Power Module (new)	5.65 x 1.65	 0143928			
	Cove Module	5.25 x 2	 0120692			
Extron	Cable Cubby 202	7 x 3.25	 0120682			
	Cable Cubby 500	5.75 x 5.75	 0120683			
	Cable Cubby 700	7.125 x 5.75	 0120684			
	TLP 350MV	5.781 x 3.875	 0120685			
	TLP Pro 320M	5.51 x 3.82	 0120686			
	TLP Pro 520M					
	TLP Pro 720M	7.5 x 5.813	 0120687			
	MLC226 IP	5.4 x 2.9	 0120688			
	MLC226 IP DV+	9.375 x 3.875	 0120689			
	MLC226 IP AAP					
AAP 104	7.25 x 2.93	 0120690				
Crestron	TSW-750 TSW-752 TSW-760 TSW-1050 TSW-1052 TSW-1060	3.567 x 2.375	 0120691			

Custom  
Contact Spectrum  
to order

# Warranty

## We will make it right for you!

Spectrum is committed to provide complete customer satisfaction. Each of our products is manufactured from the best materials available and each product is stringently monitored throughout the production process through our P.A.C.E. program (Product Assurance to meet Customer Expectations).

We expressly warrant that Spectrum products will be of good quality and workmanship and free from defect for the period set out in the warranty table below from the date of delivery. This warranty shall not apply to defects or damage resulting from misuse, abuse, neglect, improper care, modification or repair not authorized by Spectrum, or any other cause outside the control of Spectrum. Spectrum will, at its sole option, either repair or replace the defective product.

This warranty is exclusive; no other warranty, written or oral, is expressed or implied. This warranty is given by Spectrum to Buyer and to no other person or legal entity. No Spectrum dealer, distributor, agent or employee is authorized to make any modification or addition to this warranty.

**NOTWITHSTANDING ANYTHING TO THE CONTRARY, SPECTRUM WILL NOT UNDER ANY CIRCUMSTANCES BE LIABLE FOR INDIRECT OR LIQUIDATED DAMAGES, INCLUDING CONSEQUENTIAL, INCIDENTAL AND SPECIAL DAMAGES. IN NO EVENT SHALL SPECTRUM'S LIABILITY, WHETHER UNDER CONTRACT OR WARRANTY, IN TORT OR OTHERWISE, EXCEED THE PURCHASE PRICE RECEIVED BY SPECTRUM FOR THE PRODUCT AT ISSUE AND "RECALL ACTION" EXPENSES. SPECTRUM SHALL NOT BE SUBJECT TO ANY OTHER OBLIGATIONS OR LIABILITIES, WHETHER ARISING OUT OF BREACH OF CONTRACT, WARRANTY, TORT (INCLUDING NEGLIGENCE AND STRICT LIABILITY) OR OTHER THEORIES OF LAW, WITH RESPECT TO PRODUCTS SOLD OR SERVICES RENDERED BY SPECTRUM, OR ANY UNDERTAKINGS, ACTS OR OMISSIONS RELATING THERETO.**

Our Customer Service Department is ready to provide immediate attention to any questions, comments or concerns. They are available to answer your calls Monday through Friday from 7 am to 5 pm CST. In addition your product comments or concerns are welcome via e-mail at: [spectrum@spectrumspectrumfurniture.com](mailto:spectrum@spectrumspectrumfurniture.com).

Warranty Table

Item	Warranty Period
Adjustable Crank / Electric Desk Legs	• 1 Year
Flat Panel Desk Gas Cylinders	
Chairs <ul style="list-style-type: none"> <li>• Adjustable Height Chair Parts – including frames, gas cylinders, wood and plastic parts, control handles, casters</li> <li>• Adjustable Height Chair Upholstery</li> <li>• In-Stock Upholstery</li> <li>• Graded-In Fabrics and Customer Owned Material</li> </ul>	<ul style="list-style-type: none"> <li>• 7 Years</li> <li>• 2 Years</li> <li>• 2 Years</li> <li>• No Warranty</li> </ul>
Height Adjustable Columns and Lifts	• 1 Year
General Use Casters	
Electrical (including timers and LINAK actuators)	• 2 Years
Keyboard / Mouse Trays	• 1 Year
Flat Panel Monitor Arms <ul style="list-style-type: none"> <li>• Flat Panel Monitor Arm – General Parts</li> <li>• Flat Panel Monitor Arm – Gas Cylinders</li> </ul>	• 10 Years
Desks and Lecterns <ul style="list-style-type: none"> <li>• Computer Desk Chassis</li> <li>• Cart Chassis</li> <li>• Lectern Chassis</li> </ul>	• 10 Years

